



868-M

## Operating Instructions

**IMPORTANT**  
**READ CAREFULLY BEFORE USE**  
**KEEP FOR FUTURE REFERENCE**

All rights reserved.

Property of Dürkopp Adler AG and protected by copyright.  
Any reuse of these contents, including extracts, is prohibited without  
the prior written approval of Dürkopp Adler AG.

Copyright © Dürkopp Adler AG 2017

<b>1</b>	<b>About these instructions .....</b>	<b>5</b>
1.1	For whom are these instructions intended? .....	5
1.2	Representation conventions – symbols and characters .....	6
1.3	Other documents .....	7
1.4	Liability .....	8
<b>2</b>	<b>Safety.....</b>	<b>9</b>
2.1	Basic safety instructions.....	9
2.2	Signal words and symbols used in warnings.....	10
<b>3</b>	<b>Machine description.....</b>	<b>15</b>
3.1	Components of the machine .....	15
3.2	Proper use.....	16
3.3	Declaration of Conformity .....	17
<b>4</b>	<b>Operation .....</b>	<b>19</b>
4.1	Preparing the machine for operation .....	19
4.2	Switching on and off the machine .....	20
4.3	Switching on and off the sewing lamp .....	21
4.4	Inserting/changing the needle .....	24
4.4.1	In 1-needle machines .....	25
4.4.2	In 2-needle machines .....	26
4.5	Threading the needle thread .....	28
4.5.1	In 1-needle machines .....	28
4.5.2	In 2-needle machines .....	34
4.6	Winding the hook thread .....	41
4.7	Changing the bobbin .....	44
4.7.1	Changing the right bobbin .....	45
4.7.2	Changing the left bobbin .....	46
4.8	Thread tension .....	47
4.8.1	Setting the needle thread tension.....	48
4.8.2	Opening the needle thread tension .....	51
4.8.3	Switching on and off the additional tensioner.....	51
4.8.4	Setting the hook thread tension.....	52
4.9	Setting the needle thread regulator .....	53
4.9.1	In 1-needle machines .....	53
4.9.2	In 2-needle machines .....	54
4.10	Locking the sewing feet at top dead center.....	56
4.11	Sewing foot stroke.....	57
4.11.1	Limiting of number of stitches with an increased sewing foot stroke...	57
4.11.2	Setting the sewing foot stroke .....	58
4.11.3	Quick stroke adjustment via knee button .....	60
4.12	Lifting the sewing feet.....	61
4.12.1	Mechanical lifting with the knee lever.....	61

4.12.2	Electropneumatic lifting with the pedal .....	62
4.13	Setting the sewing foot pressure .....	63
4.14	Buttons on the push button panel.....	64
4.14.1	Switching on and off the function of a button .....	66
4.14.2	Assigning functions to the favorite button.....	67
4.15	LEDs on the machine arm.....	68
4.16	Remaining thread monitor .....	69
4.17	Sewing backwards with the stitch adjustment lever .....	72
4.18	Stitch length.....	73
4.18.1	Setting the stitch length .....	73
4.18.2	Sewing with 2 stitch lengths .....	75
4.18.3	Removing blocking of the adjusting wheels .....	76
4.19	Additional equipment seam middle guide.....	77
4.20	Sewing.....	80
4.20.1	Pressing the pedal.....	80
4.20.2	Sewing with the machine.....	83
<b>5</b>	<b>Programming .....</b>	<b>87</b>
5.1	Buttons on the control panel.....	88
5.2	Assigning functions to buttons on the push button panel .....	92
5.3	Assigning a function to the knee button .....	93
<b>6</b>	<b>Maintenance.....</b>	<b>95</b>
6.1	Cleaning .....	97
6.2	Lubricating.....	99
6.2.1	Checking the oil level .....	101
6.2.2	Setting the hook lubrication .....	102
6.3	Servicing the pneumatic system.....	104
6.3.1	Setting the operating pressure .....	104
6.3.2	Draining the water condensation .....	106
6.3.3	Cleaning the filter element.....	107
6.4	Parts list.....	108
<b>7</b>	<b>Setup .....</b>	<b>109</b>
7.1	Checking the scope of delivery .....	109
7.2	Removing the transport locks .....	109
7.3	Assembling the stand .....	110
7.4	Assembling the control .....	111
7.5	Completing the tabletop .....	112
7.6	Assembling the pedal and setpoint device .....	117
7.7	Inserting the machine head.....	119
7.8	Setting the working height .....	122
7.9	Setting the pedal .....	123
7.10	Assembling the control panel .....	124
7.11	Assembling the knee lever / knee button .....	125

---

7.11.1	Assembling the mechanical knee lever .....	125
7.11.2	Assembling the electric knee button.....	126
7.12	Assembling the oil extraction line .....	127
7.13	Electrical connection .....	128
7.14	Establishing equipotential bonding.....	128
7.15	Pneumatic connection .....	129
7.15.1	Assembling the compressed air maintenance unit.....	130
7.15.2	Setting the operating pressure .....	130
7.16	Checking the lubrication .....	131
7.17	Performing a test run .....	131
<b>8</b>	<b>Decommissioning .....</b>	<b>133</b>
<b>9</b>	<b>Disposal .....</b>	<b>135</b>
<b>10</b>	<b>Troubleshooting .....</b>	<b>137</b>
10.1	Customer Service .....	137
10.2	Messages of the software .....	137
10.2.1	Information messages .....	138
10.2.2	Error messages .....	142
10.3	Errors in sewing process .....	146
<b>11</b>	<b>Technical data .....</b>	<b>149</b>
11.1	Data and characteristic values .....	149
11.2	Permissible maximum speeds.....	150
11.3	Characteristics.....	151
<b>12</b>	<b>Appendix .....</b>	<b>153</b>



## 1 About these instructions



These instructions have been prepared with utmost care. They contain information and notes intended to ensure long-term and reliable operation.

Should you notice any discrepancies or if you have improvement requests, then we would be glad to receive your feedback through **Customer Service** ( p. 137).

Consider the instructions part of the product and store them in a place where they are readily available.

### 1.1 For whom are these instructions intended?

These instructions are intended for:

- **Operators:**  
This group is familiar with the machine and has access to the instructions. Specifically, chapter **Operation** ( p. 19) is important for the operators.
- **Specialists:**  
This group has the appropriate technical training for performing maintenance or repairing malfunctions. Specifically, the chapter **Setup** ( p. 109) is important for specialists.

Service Instructions are supplied separately.

With regard to minimum qualification and other requirements to be met by personnel, please also follow the chapter **Safety** ( p. 9).

## 1.2 Representation conventions – symbols and characters

Various information in these instructions is represented or highlighted by the following characters in order to facilitate easy and quick understanding:



### Proper setting

Specifies proper setting.



### Disturbances

Specifies the disturbances that can occur from an incorrect setting.



### Cover

Specifies which covers must be disassembled in order to access the components to be set.



### Steps to be performed when operating the machine (sewing and equipping)



### Steps to be performed for service, maintenance, and installation



### Steps to be performed via the software control panel

The individual steps are numbered:

1. First step
  2. Second step
  - ...
- The steps must always be followed in the specified order.
- Lists are marked by bullet points.



### Result of performing an operation

Change to the machine or on the display/control panel.



### Important

Special attention must be paid to this point when performing a step.





### Information

Additional information, e.g. on alternative operating options.

---



### Order

Specifies the work to be performed before or after a setting.

### References



Reference to another section in these instructions.

**Safety** Important warnings for the user of the machine are specifically marked. Since safety is of particular importance, hazard symbols, levels of danger and their signal words are described separately in the chapter **Safety** ( p. 9).

**Location information** If no other clear location information is used in a figure, indications of **right** or **left** are always from the user's point of view.

## 1.3 Other documents

The machine includes components from other manufacturers. Each manufacturer has performed a hazard assessment for these purchased parts and confirmed their design compliance with applicable European and national regulations. The proper use of the built-in components is described in the corresponding manufacturer's instructions.

## **1.4 Liability**

All information and notes in these instructions have been compiled in accordance with the latest technology and the applicable standards and regulations.

Dürkopp Adler cannot be held liable for any damage resulting from:

- Breakage and damage during transport
- Failure to observe these instructions
- Improper use
- Unauthorized modifications to the machine
- Use of untrained personnel
- Use of unapproved parts

### **Transport**

Dürkopp Adler cannot be held liable for breakage and transport damages. Inspect the delivery immediately upon receiving it. Report any damage to the last transport manager. This also applies if the packaging is not damaged.

Leave machines, equipment and packaging material in the condition in which they were found when the damage was discovered. This will ensure any claims against the transport company.

Report all other complaints to Dürkopp Adler immediately after receiving the product.

## 2 Safety

This chapter contains basic information for your safety. Read the instructions carefully before setting up or operating the machine. Make sure to follow the information included in the safety instructions. Failure to do so can result in serious injury and property damage.



### 2.1 Basic safety instructions

The machine may only be used as described in these instructions. The instructions should be available at the machine's location at all times.

Work on live components and equipment is prohibited. Exceptions are defined in the DIN VDE 0105.

For the following work, switch off the machine at the main switch or disconnect the power plug:

- Replacing the needle or other sewing tools
- Leaving the workstation
- Performing maintenance work and repairs
- Threading

Missing or faulty parts could impair safety and damage the machine. Only use original parts from the manufacturer.

**Transport** Use a lifting carriage or forklift to transport the machine. Raise the machine max. 20 mm and secure it to prevent it from slipping off.

**Setup** The connecting cable must have a power plug approved in the relevant country. The power plug may only be assembled to the power cable by qualified specialists.

**Obligations of the operator** Follow the country-specific safety and accident prevention regulations and the legal regulations concerning industrial safety and the protection of the environment.

All the warnings and safety signs on the machine must always be in legible condition. Do not remove!  
Missing or damaged warnings and safety signs must be replaced immediately.

**Requirements to be met by the personnel**

Only qualified specialists may:

- set up the machine
- perform maintenance work and repairs
- perform work on electrical equipment

Only authorized persons may work on the machine and must first have understood these instructions.

**Operation**

Check the machine during operating for any externally visible damage. Stop working if you notice any changes to the machine. Report any changes to your supervisor. Do not use a damaged machine any further.

**Safety equipment**

Safety equipment should not be removed or deactivated. If it is essential to remove or deactivate safety equipment for a repair operation, it must be assembled and put back into operation immediately afterward.

## 2.2 Signal words and symbols used in warnings





Warnings in the text are distinguished by color bars.  
The color scheme is based on the severity of the danger.  
Signal words indicate the severity of the danger.

**Signal words** Signal words and the hazard they describe:

Signal word	Meaning
<b>DANGER</b>	(with hazard symbol) If ignored, fatal or serious injury will result
<b>WARNING</b>	(with hazard symbol) If ignored, fatal or serious injury can result

<b>CAUTION</b>	(with hazard symbol) If ignored, moderate or minor injury can result
<b>CAUTION</b>	(with hazard symbol) If ignored, environmental damage can result
<b>NOTICE</b>	(without hazard symbol) If ignored, property damage can result

**Symbols** The following symbols indicate the type of danger to personnel:

Symbol	Type of danger
	General
	Electric shock
	Puncture
	Crushing
	Environmental damage

**Examples** Examples of the layout of warnings in the text:

**DANGER**



**Type and source of danger!**

Consequences of non-compliance.

Measures for avoiding the danger.

↪ This is what a warning looks like for a hazard that will result in serious injury or even death if ignored.

**WARNING**



**Type and source of danger!**

Consequences of non-compliance.

Measures for avoiding the danger.

↪ This is what a warning looks like for a hazard that could result in serious or even fatal injury if ignored.

**CAUTION**



**Type and source of danger!**

Consequences of non-compliance.

Measures for avoiding the danger.

↪ This is what a warning looks like for a hazard that could result in moderate or minor injury if the warning is ignored.

### NOTICE

#### **Type and source of danger!**

Consequences of non-compliance.

Measures for avoiding the danger.

- ↪ This is what a warning looks like for a hazard that could result in property damage if ignored.

### CAUTION



#### **Type and source of danger!**

Consequences of non-compliance.

Measures for avoiding the danger.

- ↪ This is what a warning looks like for a hazard that could result in environmental damage if ignored.





### 3 Machine description

#### 3.1 Components of the machine

Fig. 1: Components of the machine

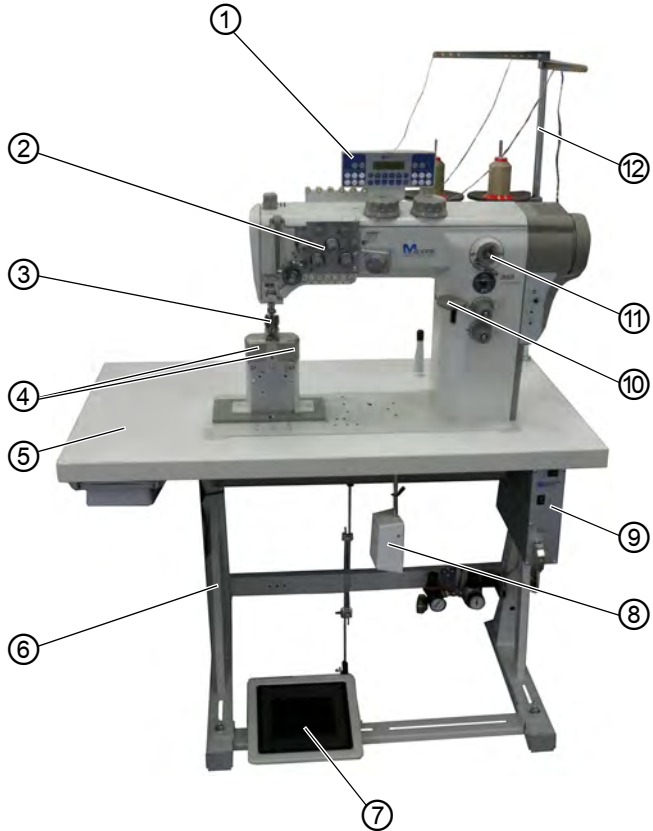

- (1) - Control panel OP1000
- (2) - Tensioning plate
- (3) - Needle bar
- (4) - Hook
- (5) - Tabletop
- (6) - Stand

- (7) - Pedal
- (8) - Knee button
- (9) - Control (DAC classic)
- (10) - Stitch adjustment lever
- (11) - Winder
- (12) - Reel stand

## 3.2 Proper use

### WARNING



#### **Risk of injury from live, moving and cutting parts as well as from sharp parts!**

Improper use can result in electric shock, crushing, cutting and punctures.

Follow all instructions provided.

### NOTICE

#### **Non-observance will lead to property damage!**

Improper use can result in material damage at the machine.

Follow all instructions provided.

The machine may only be used with sewing material that satisfies the requirements of the specific application at hand.

The machine is intended only for use with dry sewing material. The sewing material must not contain any hard objects.

The needle thicknesses permissible for the machine are listed in the **Technical data** (📖 p. 149) chapter.

The seam must be completed with a thread that satisfies the requirements of the specific application at hand.

The machine is intended for industrial use.

The machine may only be set up and operated in dry conditions on well-maintained premises. If the machine is operated on premises that are not dry and well-maintained, then further measures may be required which must be compatible with DIN EN 60204-31.

Only authorized persons may work on the machine.

Dürkopp Adler cannot be held liable for damages resulting from improper use.

---

### 3.3 Declaration of Conformity

The machine complies with European regulations ensuring health, safety, and environmental protection as specified in the declaration of conformity or in the declaration of incorporation.





## 4 Operation

The operating sequence consists of several different steps. Fault-free operation is necessary in order to achieve a good sewing result.

### 4.1 Preparing the machine for operation

#### WARNING







#### **Risk of injury from moving, cutting and sharp parts!**

Crushing, cutting and punctures are possible.

If possible, make preparations only when the machine is switched off.

Complete the following steps in preparation of sewing before starting to work:

- Inserting/changing the needle ( p. 24)
- Threading the needle thread ( p. 28)
- Inserting and winding on the hook thread ( p. 41)
- Setting the thread tension ( p. 47)

## 4.2 Switching on and off the machine

Fig. 2: Switching on and off the machine (1)



(1) - Main switch

### Switching on the machine



To switch on the machine:

1. Set the main switch (1) to position I.

Fig. 3: Switching on and off the machine (2)



(2) - LED light

(3) - LED light

- LED lights (2) and (3) are lit, indicating that the machine is ready for use.

### Switching off the machine



To switch off the machine:

1. Set the main switch (1) to position **0**.
- ↳ LED lights (2) and (3) are no longer lit, indicating that the machine is switched off and powered off.

### 4.3 Switching on and off the sewing lamp

On CLASSIC machines, you switch the sewing lamp on and off independently from the main switch / the machine itself.

Fig. 4: Switching on and off the sewing lamp (1)



(1) - Switch

### Switching on the sewing lamp



To switch on the sewing lamp:

1. Set the switch (1) to position **I**.

Fig. 5: Switching on and off the sewing lamp (2)



(2) - Button  
(3) - Button

(4) - Rotary knob



2. To switch on the integrated sewing lamp, press button (2).  
↳ The sewing lamp illuminates.
3. To switch on an external sewing lamp, press button (3).  
↳ The external sewing lamp illuminates.



### Information

An integrated sewing lamp may be included depending on the equipment of the machine. An external sewing lamp is not included in the scope of delivery.

Disconnection from the power supply requires that the external/integrated sewing lamp be switched off directly, independently from the machine.

### Setting the brightness



To set the brightness of the external/integrated sewing lamp:

1. Press and hold button (2)/(3) until the sewing lamp flashes briefly.  
↳ You can now set the brightness.



2. Setting the brightness:
    - set to a brighter level: Turn the rotary knob (4) clockwise
    - set to a darker level: Turn the rotary knob (4) counterclockwise
  3. Briefly press the button (2)/(3) once.
- ↳ The sewing lamp flashes once, indicating that the brightness level has been saved.

### Switching off the sewing lamp



To switch off the sewing lamp:

1. To switch off the integrated sewing lamp, press button (2).
  2. To switch off the external sewing lamp, press button (3).
- ↳ The sewing lamp is no longer lit.
3. Set the switch (1) to position **0**.
- ↳ The sewing lamps are now powered off.

## 4.4 Inserting/changing the needle

### CAUTION



#### **Risk of injury from sharp parts!**

Punctures possible.

Switch off the machine before you insert or change the needle.

### NOTICE

#### **Property damage may occur!**

There is a risk of machine damage, needle breakage or thread breakage if the distance between needle and hook tip is incorrect.

Check the distance to the hook tip after inserting a needle with a different thickness.

#### 4.4.1 In 1-needle machines

Fig. 6: In 1-needle machines

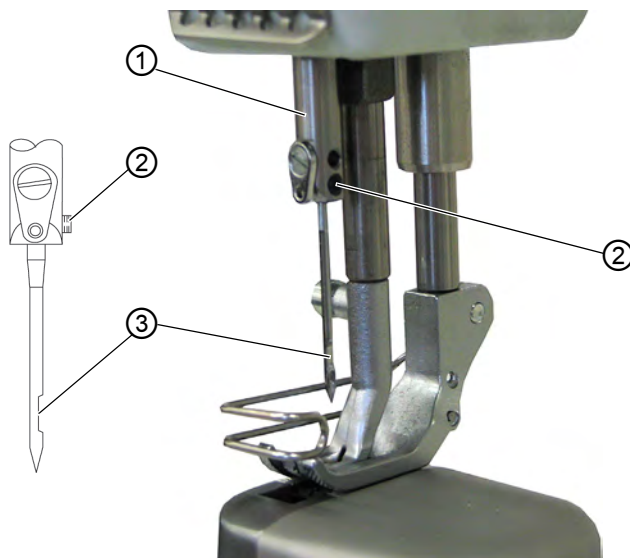

(1) - Needle bar  
(2) - Screw

(3) - Groove



To change the needle in a 1-needle machine:

1. Turn the handwheel until the needle bar (1) has reached the upper end position.
2. Loosen the screw (2).
3. Pull the needle out towards the bottom.
4. Insert the new needle into the hole in the needle bar (1) until it reaches the end stop.



#### Important

Align the new needle in such a way that the groove (3) faces the hook.

5. Tighten the screw (2).



#### Order

Always adjust the clearance between the hook and the needle after changing to a different needle thickness ( *Service Instructions*).

## Disturbance

An incorrect hook distance can cause the following disturbances:

- Changing to a thinner needle:
  - Missing stitches
  - Thread damage
- Changing to a thicker needle:
  - Damage to the hook tip
  - Damage to the needle

### 4.4.2 In 2-needle machines

Fig. 7: In 2-needle machines



(1) - Needle bar

(2) - Screw

(3) - Groove

(4) - Needle holder



To change the needle in a 2-needle machine:

1. Turn the handwheel until the needle bar (1) has reached the upper end position.
2. To change the right needle, loosen the right screw (2).
3. To change the left needle, loosen the left screw (2).
4. Pull the needle(s) downwards out of the needle holder (4).
5. Insert new needle(s) into the corresponding hole of the needle holder (4) until you reach the stop.

### Important

Align the new needles in such a way that the grooves (3) face the hook. As viewed from the user side, the groove (3) of the left needle must point to the left, while the groove (3) of the right needle must point to the right.

6. Tighten the screw (2).



### Order

Always adjust the clearance between the hook and the needle after changing to a different needle thickness ( *Service Instructions*).



### Disturbance

An incorrect hook distance can cause the following disturbances:

- Changing to a thinner needle:
  - Missing stitches
  - Thread damage
- Changing to a thicker needle:
  - Damage to the hook tip
  - Damage to the needle

## 4.5 Threading the needle thread

### 4.5.1 In 1-needle machines

#### WARNING



**Risk of injury from needle tip and moving parts!**

Puncture, cutting and crushing possible.

Switch off the machine before threading the needle thread.



To thread the needle thread:

1. Fit the thread reel on the reel stand.

The unwinding bracket (1) must stand directly above the thread reel.

Fig. 8: In 1-needle machines (1)

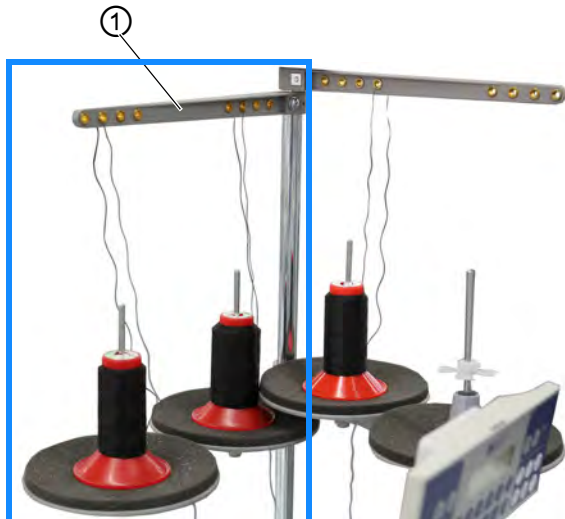

(1) - Unwinding bracket

Fig. 9: In 1-needle machines (2)



(1) - Unwinding bracket



2. Insert the needle thread from the rear to the front through the thread guide on the unwinding bracket (1).

Fig. 10: In 1-needle machines (3)

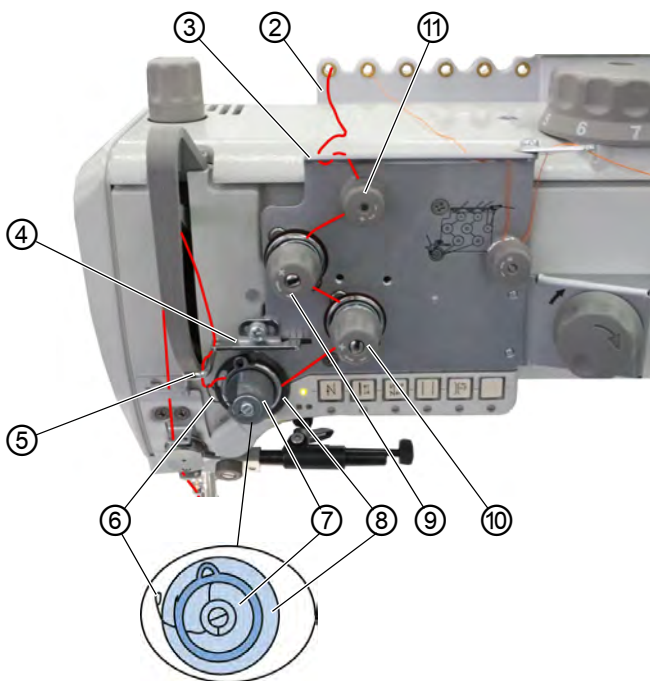

- |                               |                             |
|-------------------------------|-----------------------------|
| (2) - Thread guide            | (7) - Thread tension spring |
| (3) - Thread guide            | (8) - Tightening lever      |
| (4) - Needle thread regulator | (9) - Additional tensioner  |
| (5) - Hook                    | (10) - Main tensioner       |
| (6) - Spring tip              | (11) - Pre-tensioner        |



3. Insert the needle thread from the rear to the front through the thread guide (2).
4. Insert the needle thread in a wavelike manner through the left holes of the thread guide (3): From the top left to the bottom, from the bottom to the top and from the top to the bottom.
- ↳ The needle thread must be inserted into the thread guide (3) through three holes.
5. Guide the needle thread clockwise around the pre-tensioner (11).
6. Guide the needle thread counterclockwise around the additional tensioner (9).
7. Guide the needle thread clockwise around the main tensioner (10).
8. Guide the needle thread clockwise to the thread tension spring (7).
9. Lift the tightening lever (8) with the needle thread.
10. Pull the needle thread under the spring tip (6).
11. Guide the needle thread under the hook (5).
12. Insert the needle thread from the bottom through the hole on the needle thread regulator (4).



Fig. 11: In 1-needle machines (4)

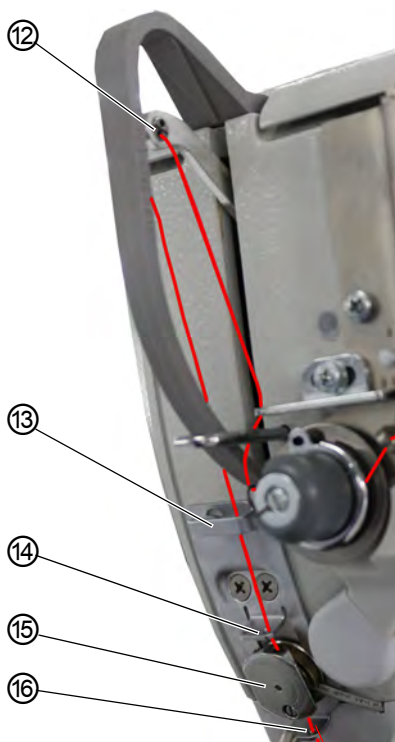

- |  |                    |
|--|--------------------|
| (12)- Thread lever                           | (15)- Thread clamp |
| (13)- Upper thread guide                     | (16)- Thread guide |
| (14)- Upper thread guide of the thread clamp |                    |



13. Thread the needle thread from the right through the lower hole on the thread lever (12).
14. Insert the needle thread through the upper thread guide (13).



**For machines with thread clamp (optional)**

15. Insert the needle thread through the right hole of the thread guide above the thread clamp (14).
16. Insert the needle thread through the right hole of the thread clamp (15).

Fig. 12: In 1-needle machines (5)

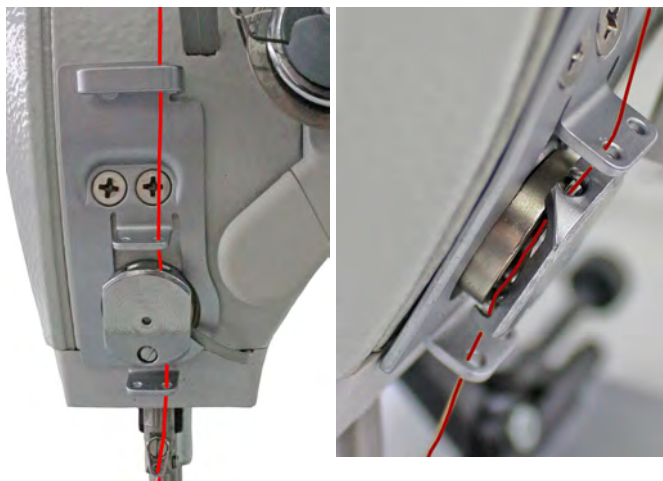

17. Insert the needle thread into the thread clamp (15) from the left so that the thread is held in place inside the hook of the thread clamp (15).

The needle thread is supposed to run through the thread clamp almost without touching it and in such a way that it only makes contact with the thread guides above and below the thread clamp.

Fig. 13: In 1-needle machines (6)

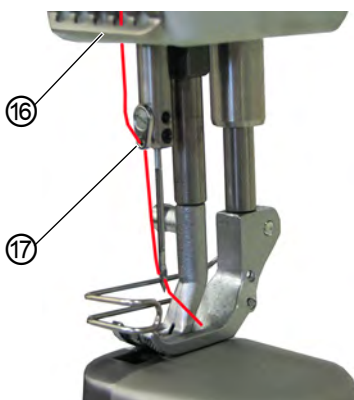

(16) - Thread guide

(17) - Thread guide of the needle bar



18. Insert the needle thread through the right hole of the thread guide (16).



### Important

Fig. 14: In 1-needle machines (7)

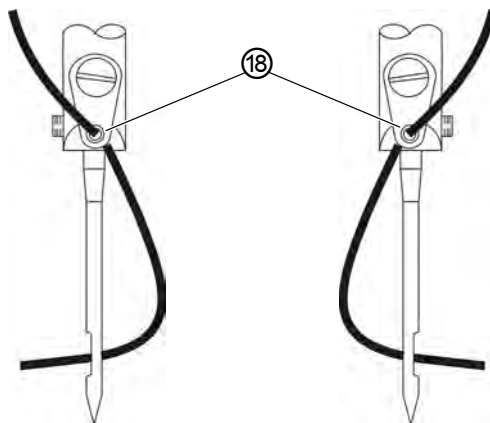

For 868-390XXX-M

For 868-190XXX-M



19. Insert the needle thread through the thread guide of the needle bar (17).

20. Insert the needle thread through the needle eye in such a way that the loose thread end faces the hook.



### For machines with thread cutter

21. Pull the needle thread through the needle eye until the loose thread end has a length of approx. 4 cm with the thread lever (12) at the highest position.



### Important

Check the thread length.

If the loose thread end is too long, the needle thread may be caught by the hook and cause a disturbance. If the loose thread end is too short, the machine cannot start sewing.

## 4.5.2 In 2-needle machines

### WARNING



**Risk of injury from needle tip and moving parts!**

Puncture, cutting and crushing possible.

Switch off the machine before threading the needle threads.



To thread the right and the left needle thread:

1. Fit the thread reels on the reel stands.

The unwinding bracket (1) must stand directly above the thread reels.

Fig. 15: In 2-needle machines (1)

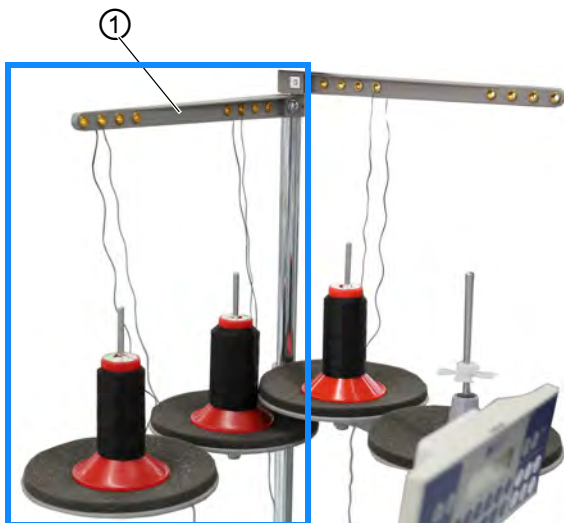

(1) - Unwinding bracket

Fig. 16: In 2-needle machines (2)



(1) - Unwinding bracket



2. Insert the right needle thread from the rear to the front through the right thread guide on the unwinding bracket (1).
3. Insert the left needle thread from the rear to the front through the left thread guide on the unwinding bracket (1).

## Threading the right needle thread at the tensioning plate

Fig. 17: In 2-needle machines (3)

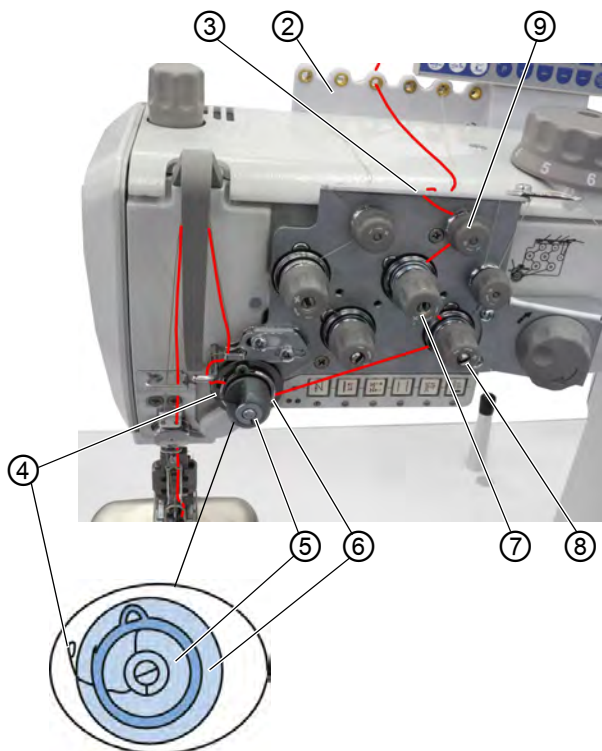

- |                             |  |
|-----------------------------|--|
| (2) - Thread guide          | (7) - Additional tensioner (right needle thread) |
| (3) - Thread guide          | (8) - Main tensioner (right needle thread)       |
| (4) - Spring tip            | (9) - Pre-tensioner (right needle thread)        |
| (5) - Thread tension spring |  |
| (6) - Tightening lever      |  |



4. Insert the needle thread from the rear to the front through the thread guide (2).
5. Insert the needle thread in a wavelike manner through the 3 center holes of the thread guide (3): From the center at the top right to the bottom, from the bottom to the top and from the top to the bottom.
6. Guide the needle thread clockwise around the pre-tensioner (9).
7. Guide the needle thread counterclockwise around the additional tensioner (7).

8. Guide the needle thread clockwise around the main tensioner (8).
9. Guide the needle thread clockwise to the thread tension spring (5).
10. Lift the tightening lever (6) with the needle thread.
11. Pull the needle thread under the spring tip (4).

### Threading the left needle thread at the tensioning plate

Fig. 18: In 2-needle machines (4)

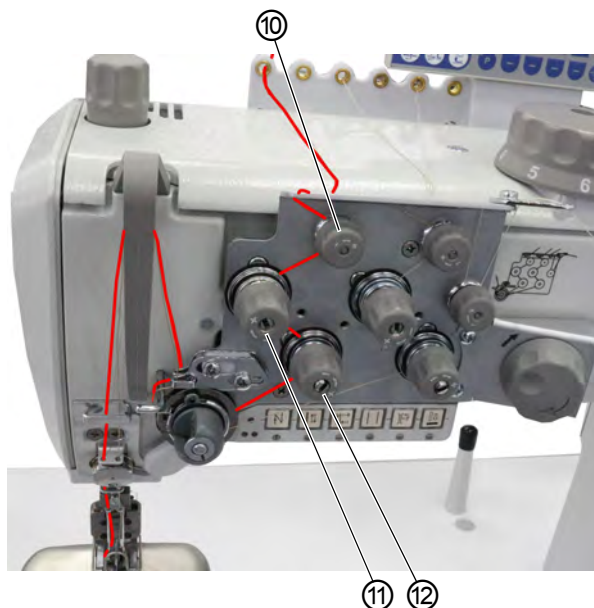

- (10) - Pre-tensioner (left needle thread)      (12) - Main tensioner (left needle thread)  
 (11) - Additional tensioner (left needle thread)



12. Insert the left needle thread from the rear to the front left through the thread guide (2).
13. Insert the left needle thread in a wavelike manner through the 3 left holes of the thread guide (3): From the center at the top right to the bottom, from the bottom to the top and from the top to the bottom.
14. Guide the needle thread clockwise around the pre-tensioner (10).

15. Guide the needle thread counterclockwise around the additional tensioner (11).
16. Guide the needle thread clockwise around the main tensioner (12).
17. Guide the needle thread clockwise to the thread tension spring (5).
18. Lift the tightening lever (6) with the needle thread.
19. Pull the needle thread under the spring tip (4).

### Threading the needle thread at the needle thread regulator

Fig. 19: In 2-needle machines (5)

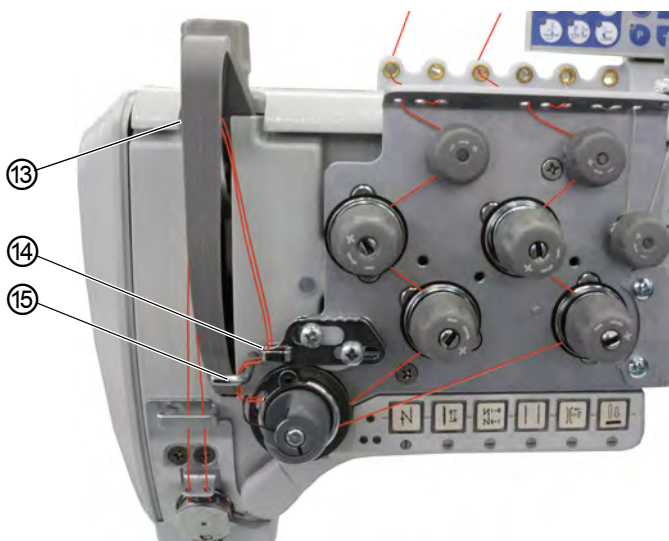

(13) - Thread lever (not visible)  
(14) - Needle thread regulator

(15) - Hook



20. Guide the right needle thread behind the hook (15).
21. Guide the left needle thread behind the hook (15).
22. Thread the right needle thread from the bottom through the front hole on the needle thread regulator (14).
23. Thread the left needle thread from the bottom through the rear hole on the needle thread regulator (14).
24. Thread the right needle thread from the right through the lower hole on the thread lever (13).



25. Thread the left needle thread from the right through the upper hole on the thread lever (13).

Fig. 20: In 2-needle machines (6)

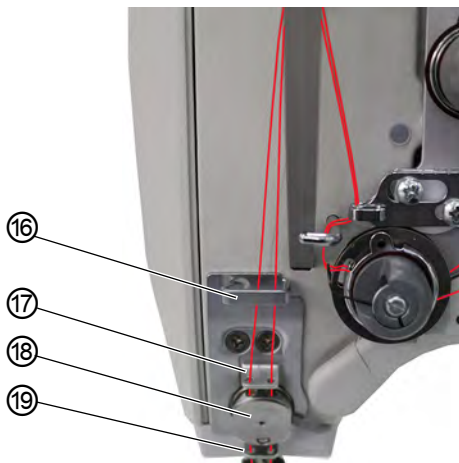

(16) - Upper thread guide  
(17) - Thread guide

(18) - Thread clamp  
(19) - Thread guide



26. Insert the right and the left needle thread through the upper thread guide (16).

### For machines with thread clamp (optional)

27. Insert the right needle thread through the right hole of the thread guide (17).
28. Insert the left needle thread through the left hole of the thread guide (17).
29. Insert the right needle thread through the right hole of the thread clamp (18).
- The needle thread is supposed to run through the clamp almost without touching it and in such a way that it only makes contact with thread guides (17) and (19).
30. Insert the left needle thread through the left hole of the thread clamp (18).
31. Insert the right needle thread through the right hole of the thread guide (19).

32. Insert the left needle thread through the left hole of the thread guide (19).

Fig. 21: In 2-needle machines (7)



(19) - Thread guide

(20) - Thread guide



33. Insert the right needle thread through the right hole of the thread guide (20).
34. Insert the left needle thread through the left hole of the thread guide (20).
35. Insert the right needle thread through the right needle eye in such a way that the loose thread end faces the right hook.
36. Insert the left needle thread through the left needle eye in such a way that the loose thread end faces the left hook.



**For machines with thread cutter**

37. Pull each needle thread through the needle eye until the loose thread end has a length of approx. 4 cm with the thread lever (13) at the highest position.



**Important**

Check the thread length.

If the loose thread end is too long, the needle thread may be caught by the hook and cause a disturbance. If the loose thread end is too short, the machine cannot start sewing.

## 4.6 Winding the hook thread

### WARNING



**Risk of injury from needle tip and moving parts!**

Puncture, cutting and crushing possible.

Switch off the machine before threading the needle thread.



To thread the hook thread:

1. Fit the thread reel on the reel stand.

The unwinding bracket (1) must stand directly above the thread reel.

*Fig. 22: Winding the hook thread (1)*

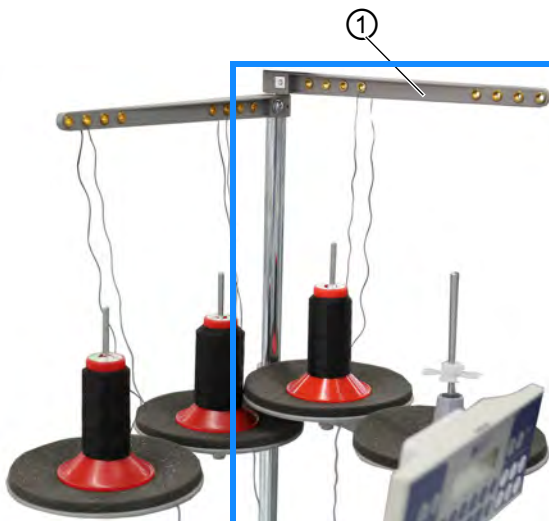

*(1) - Unwinding bracket*

Fig. 23: Winding the hook thread (2)



(1) - Unwinding bracket



2. Insert the hook thread from the rear to the front through the right thread guide on the unwinding bracket (1).

Fig. 24: Winding the hook thread (3)

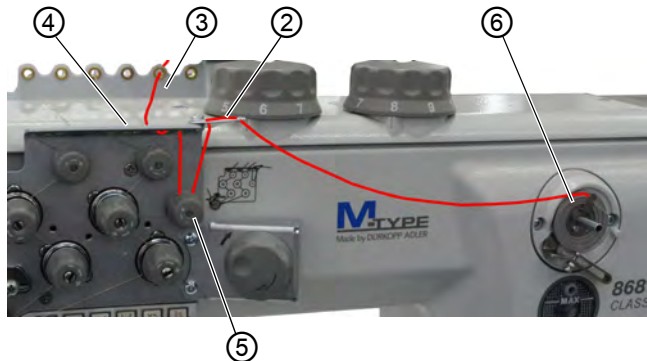

(2) - Thread guide  
(3) - Thread guide  
(4) - Thread guide

(5) - Pre-tensioner  
(6) - Winder



3. Insert the hook thread from the rear to the front through the thread guide (3).
  4. Insert the hook thread in a wavelike manner through the 3 right holes of the thread guide (4): From the top into the left hole, from the bottom into the center hole, and from the top into the right hole.
- ☞ The last hole is the hole on the far right in the thread guide (4).

5. Guide the hook thread counterclockwise around the pre-tensioner (5).
6. Insert the hook thread through thread guide (2): From the bottom left to the top and from the top to the bottom.
  - ↳ The last hole is the hole on the far right in the thread guide (2).
7. Guide the hook thread to the winder (6).

Fig. 25: Winding the hook thread (4)

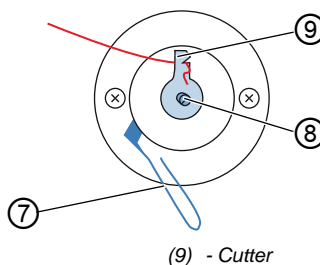

(7) - Winder lever  
(8) - Bobbin shaft

(9) - Cutter



8. Clamp the hook thread behind the cutter (9) and tear off the loose end behind it.
9. Fit the empty bobbin onto the bobbin shaft (8).
10. Turn the bobbin clockwise until it clicks.
11. Pull the winder lever (7) up against the bobbin.
12. Switch on the machine.
13. Press the pedal forward to position 1.
  - ↳ The machine sews and winds the hook thread from the thread reel onto the bobbin. When the bobbin is filled, the winding process stops. The winder lever moves back down. The cutter is automatically moved to its vertical initial position.
14. Remove the full bobbin from the bobbin shaft (8).
15. Tear off the hook thread behind the cutter (9).

You can now fill the next bobbin. You can insert the full bobbin into the hook.

## 4.7 Changing the bobbin

### WARNING



**Risk of injury from needle tip and moving parts!**

Puncture, cutting and crushing possible.

Turn off the machine before changing a bobbin.



### Machines with automatic remaining thread monitor

If the hook thread needs to be replaced, the LED indicator lamps (1) light up on the machine arm. The left light is for the left-hand hook, and the right light is for the right-hand hook.

Fig. 26: Changing the bobbin

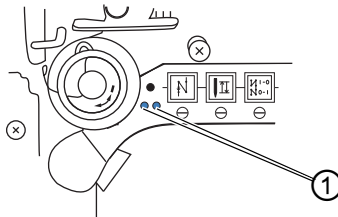

(1) - LED indicator lamp

### 4.7.1 Changing the right bobbin

Fig. 27: Changing the right bobbin

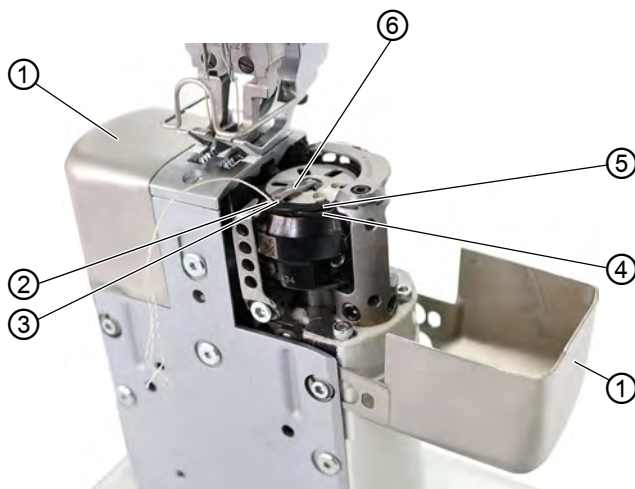

- (1) - Hook cover
- (2) - Slot
- (3) - Guide
- (4) - Tension spring

- (5) - Slot
- (6) - Bobbin case retainer



To change the right bobbin:

1. Pull the right hook cover (1) up by a few millimeters before pivoting it to the right.
2. Swivel up the bobbin case retainer (6).
3. Remove the empty bobbin.
4. Insert a full bobbin:



#### **Important**

Insert the bobbin so that it moves in the opposite direction of the hook when the thread is pulled out.



### Information

If the machine is equipped with a remaining thread monitor, the bobbins will come with a thread supply groove embedded in the bobbin core. Insert these types of bobbin in the hook in such a way that the thread supply groove faces down (📖 p. 69). Otherwise, the remaining thread monitor will not work.

5. Feed the hook thread through the slot (5) in the bobbin case retainer.
6. Pull the hook thread under the tension spring (4).
7. Feed the hook thread through the slot (2) and pull it approx. 3 cm further.
8. Close the bobbin case retainer (6).
9. Fold the hook cover (1) closed.

## 4.7.2 Changing the left bobbin

*Fig. 28: Changing the left bobbin*



The left hook has the same design as the right hook, but is rotated by 180°.



To change the left bobbin:

1. Change the left bobbin following the same order as for the right bobbin (📖 p. 45).



## 4.8 Thread tension

Together with the hook thread tension, the needle thread tension influences the final seam pattern. With thin sewing material, excessive thread tension can lead to undesired gathering and thread breakage.



### Proper setting

If the tension of needle thread and hook thread is identical, the thread interlacing lies in the middle of the sewing material. Set the needle thread tension so that the desired seam pattern is achieved with the lowest possible tension.

Fig. 29: Thread tension

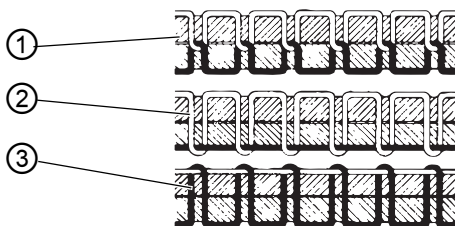

- (1) - Identical needle thread and hook thread tension
- (2) - Hook thread tension higher than needle thread tension
- (3) - Needle thread tension higher than hook thread tension

### 4.8.1 Setting the needle thread tension

#### WARNING



**Risk of injury from needle tip and moving parts!**

Puncture, cutting and crushing possible.

Switch off the machine before setting the needle thread tension.

Fig. 30: Setting the needle thread tension (1)

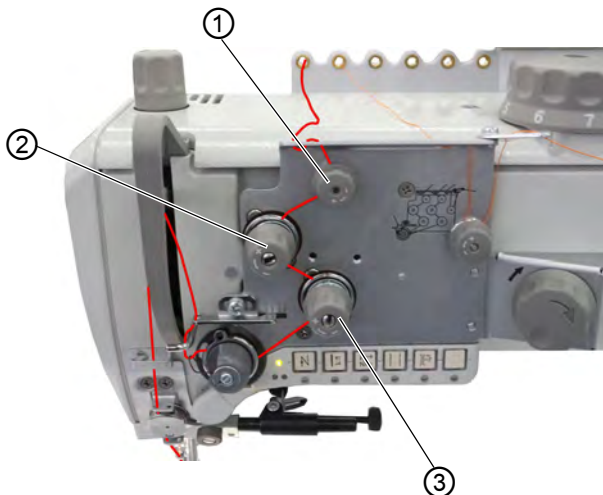

(1) - Pre-tensioner

(2) - Additional tensioner

(3) - Main tensioner

Fig. 31: Setting the needle thread tension (2)



(4) - Adjusting wheel

(5) - Bolt

### Pre-tensioner

The pre-tensioner (1) generates a residual tension of the needle thread. When main tensioner (3) and additional tensioner (2) are open, a small amount of residual tension of the needle thread is required.

The pre-tensioner also affects the length of the cut needle thread and, thus, the length of the initial thread for the new seam.



#### Proper setting

Turn the adjusting wheel (4) until the front side is flush with the bolt (5).



To set the length of the initial thread:

#### Shorter initial thread

1. Turn the adjusting wheel (4) of the pre-tensioner (1) clockwise.

#### Longer initial thread

1. Turn the adjusting wheel (4) of the pre-tensioner (1) counter-clockwise.

## Main tensioner

The main tensioner (3) must be set in such a way that the thread interlacing is exactly in the middle of the sewing material.



### Disturbance

Possible consequences of the needle thread tension is set too high:

- Gathering when using thin sewing material
- Thread breaking



### Proper setting

Set the main tensioner (3) so that an even stitch pattern is achieved.



To set the needle thread tension:

### Increasing the needle thread tension

1. Turn the adjusting wheel (4) of the main tensioner (3) clockwise.

### Reducing the needle thread tension

1. Turn the adjusting wheel (4) of the main tensioner (3) counterclockwise.

## Additional tensioner

The switchable additional tensioner (2) can be used to quickly adjust the needle thread tension, e.g. for thickened seams.



### Proper setting

The additional tensioner (2) must be set lower than the main tensioner (3).

## 4.8.2 Opening the needle thread tension

- **ECO machines:**

Main tensioner and additional tensioner are automatically opened when the sewing feet are lifted ( p. 61).

- **CLASSIC machines:**

On CLASSIC machines with thread cutter, the needle thread tension is opened automatically when the thread is cut.

## 4.8.3 Switching on and off the additional tensioner

On machines without thread cutter, the additional tensioner is switched on and off mechanically.

Fig. 32: Switching on and off the additional tensioner

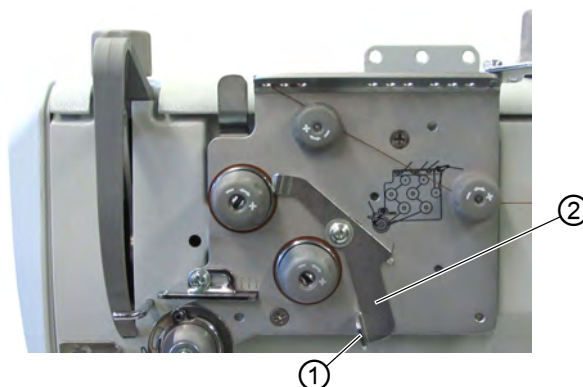

(1) - Handle

(2) - Lever



To switch the additional tensioner on:

1. Push the lever (2) on the handle (1) to the right.



To switch the additional tensioner off:

1. Push the lever (2) on the handle (1) to the left.



### Information

On machines with thread cutter, the additional tensioner is switched on and off with the press of a button housed in the push button panel.

#### 4.8.4 Setting the hook thread tension

##### WARNING



**Risk of injury from needle tip and moving parts!**

Puncture, cutting and crushing possible.

Switch off the machine before setting the hook thread tension.

Fig. 33: Setting the hook thread tension

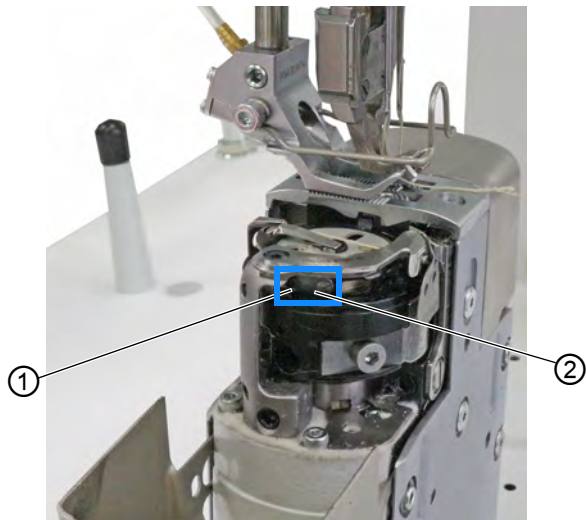

(1) - Adjusting screw

(2) - Tension spring

The hook thread tension is adjusted using the tension spring (2).



To set the hook thread tension:

##### Increasing the hook thread tension

1. Turn the adjusting screw (1) clockwise.

##### Reducing the hook thread tension

1. Turn the adjusting screw (1) counterclockwise.

## 4.9 Setting the needle thread regulator

### WARNING



#### Risk of injury from needle tip and moving parts!

Puncture, cutting and crushing possible.

Switch off the machine before setting the needle thread regulator.

The needle thread regulator determines the tension applied to guide the needle thread around the hook.



#### Proper setting

The loop of the needle thread slides at low tension over the thickest point of the hook.

### 4.9.1 In 1-needle machines

Fig. 34: In 1-needle machines

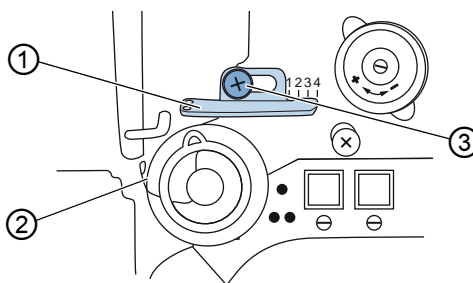

(1) - Needle thread regulator

(2) - Thread tension spring

(3) - Screw



To set the needle thread regulator for the needle thread in a 1-needle machine:

1. Loosen the screw (3).
  - **To increase the tension:**  
Slide the needle thread regulator (1) to the right
  - **To reduce the tension:**  
Slide the needle thread regulator (1) to the left
2. Tighten the screw (3).



**Information**

When the largest thread quantity is required, the thread tension spring (2) must be pulled approx. 0.5 mm up from its lower end position. This occurs when the needle thread loop passes the maximum hook diameter.

**4.9.2 In 2-needle machines**

Fig. 35: In 2-needle machines

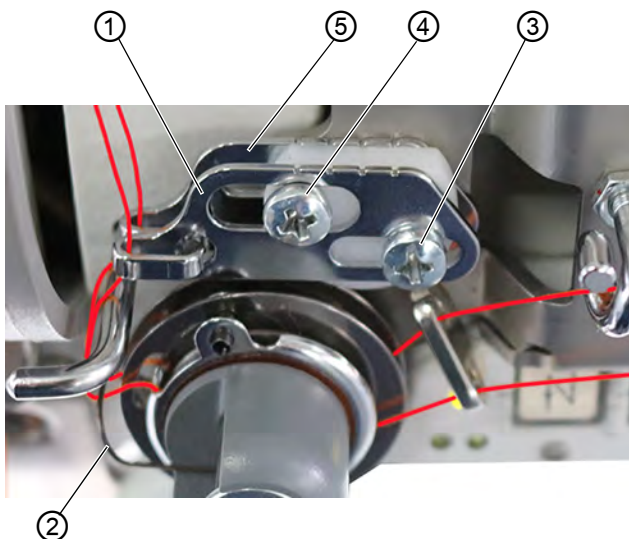

- |  |   |
|--|---|
| (1) - Needle thread regulator<br>(right needle thread) | (4) - Screw (left needle thread)                      |
| (2) - Thread tension spring                            | (5) - Needle thread regulator<br>(left needle thread) |
| (3) - Screw (right needle thread)                      |   |



To set the needle thread regulator for the right and the left needle thread in a 2-needle machine:

1. To set the needle thread regulator for the right needle thread: Loosen the screw (3).
  - **To increase the tension:**  
Slide the needle thread regulator (1) to the right.
  - **To reduce the tension:**  
Slide the needle thread regulator (1) to the left.



- 
2. Tighten the screw (3).
  3. To set the needle thread regulator for the left needle thread:  
Loosen the screw (4).
    - **To increase the tension:**  
Slide the needle thread regulator (5) to the right.
    - **To reduce the tension:**  
Slide the needle thread regulator (5) to the left.
  4. Tighten the screw (4).
- 



#### **Information**

When the largest thread quantity is required, the thread tension spring (2) must be pulled approx. 0.5 mm up from its lower end position. This occurs when the needle thread loop passes the maximum hook diameter.

---

## 4.10 Locking the sewing feet at top dead center

### CAUTION



#### Risk of injury from moving parts!

Risk of crushing when lowering the sewing foot.

Do not reach under the sewing feet.

Fig. 36: Locking the sewing feet at top dead center

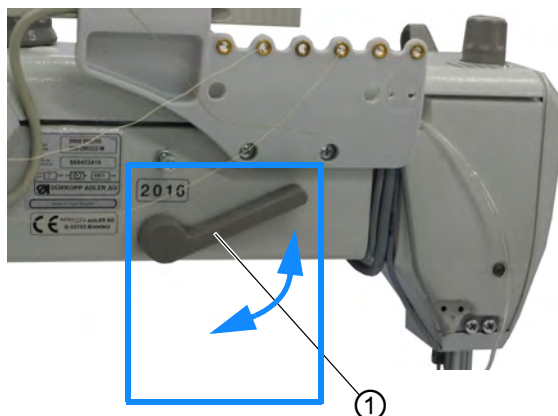

(1) - Lever



To lock the sewing feet at top dead center:

1. Swivel the lever (1) down.
- ↪ The sewing foot is locked at top dead center.
2. Swivel the lever (1) up.
- ↪ The lock is canceled.



### Information

The sewing foot can also be lifted pneumatically using the pedal or the knee button. The lever (1) will then swivel back up automatically.

## 4.11 Sewing foot stroke

### 4.11.1 Limiting of number of stitches with an increased sewing foot stroke

#### NOTICE

##### Property damage may occur!

Possible damage to the machine through an excessively high number of stitches with an increased sewing foot stroke.

Do not exceed the maximum speeds specified for the respective combination of stitch length and sewing foot stroke. When sewing with large stitch lengths and high sewing foot stroke on ECO machines, do not press the pedal forward as far as usual.

Do not change the potentiometer settings on CLASSIC machines.



#### Information

CLASSIC machines have a potentiometer on the arm shaft. The potentiometer automatically adapts the number of stitches to the sewing foot stroke: If you increase the sewing foot stroke, the number of stitches is automatically reduced.

Follow the specified maximum speeds:

Subclass	Stitch length range [mm]	Sewing foot stroke Adjusting wheel position	Maximum speed [min <sup>-1</sup> ]
868-190322-M	0-8	1-2, 5	2500
		3	2400
868-290322-M		4	2200
		5	2000
868-190020-M		6	1800
		7-9	1600
868-290020-M	8-12	1-9	1600

**Information**

The maximum speed for 2-needle machines with a needle distance greater than 20 mm must not exceed 2,000 min<sup>-1</sup>.

**Important**

ECO machines do not have automatic reduction of the number of stitches. On ECO machines, you as the user must ensure that the number of stitches specified in the technical data is not exceeded ( p. 149).

### 4.11.2 Setting the sewing foot stroke

**NOTICE**
**Property damage may occur!**

Machine can be damaged if the adjusting wheels are forced. The machine is designed in such a way that the sewing foot stroke at the right adjusting wheel cannot be set to a lower level than at the left adjusting wheel.

Do not attempt to use force to set a smaller sewing foot stroke at the right adjusting wheel than at the left adjusting wheel.

Depending on the equipment the machine has 1 or 2 adjusting wheels for the sewing foot stroke. The sewing foot stroke is continuously adjustable over a range of 1 – 9 mm by turning the adjusting wheel.

**Important**

The increased sewing foot stroke must NOT be lower than the normal sewing foot stroke. Always set the sewing foot stroke at the right adjusting wheel so that it is at least as high as the sewing foot stroke at the left adjusting wheel.

On machines with only 1 adjusting wheel, the highest stroke of 9 mm is automatically activated as the increased sewing foot stroke by pressing a button housed in the push button panel.

On CLASSIC machines with 2 adjusting wheels, the left adjusting wheel (1) sets the normal sewing foot stroke, while the right adjusting wheel (2) sets the increased sewing foot stroke. The increased sewing foot stroke can be switched on and off using the button on the push button panel or the knee button ( p. 60).

Fig. 37: Setting the stroke height



(1) - Adjusting wheel  
(normal sewing foot stroke)

(2) - Adjusting wheel (increased sewing  
foot stroke; CLASSIC machines only)

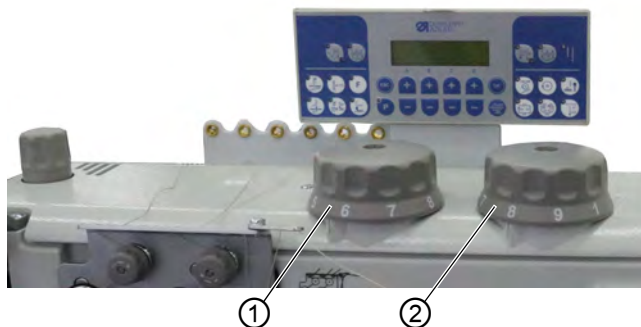

To set the sewing foot stroke:

### **Increasing the sewing foot stroke**

1. Turn the adjusting wheel (1)/(2) clockwise.

### **Reducing the sewing foot stroke**

1. Turn the adjusting wheel (1)/(2) counterclockwise.

### 4.11.3 Quick stroke adjustment via knee button

The increased sewing foot stroke can be activated using the knee lever (2).

The toggle switch (1) on the rear side of the knee button (2) determines whether the increased sewing foot stroke is switched on permanently or only while the knee button (2) is pressed.

Fig. 38: Quick stroke adjustment via knee button

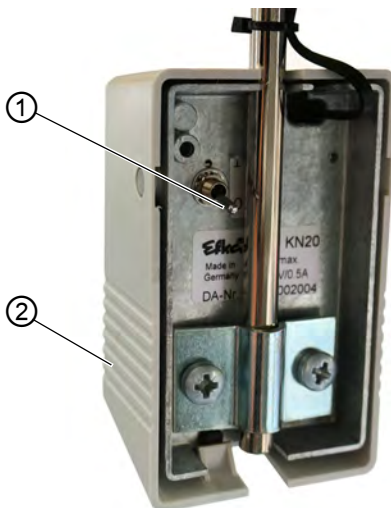

(1) - Toggle switch

(2) - Knee button

Position	Function	Description
0	Push-to-run mode	<ul style="list-style-type: none"> <li>To activate the sewing foot stroke: Press the knee button once.</li> <li>To deactivate the sewing foot stroke: Press the knee button one more time.</li> </ul>
1	Hold-to-run mode	The sewing foot stroke remains activated for as long as you hold down the knee button.



#### Information

The knee button (2) can also be assigned functions other than the activation of the sewing foot stroke in push-to-run and hold-to-run mode (📖 p. 87).





To activate the increased sewing foot stroke using the knee button:

1. Set the toggle switch (1) of the knee button (2) to the desired function:
  - Push-to-run mode: Set the toggle switch (1) to position **0**.
  - Hold-to-run mode: Set the toggle switch (1) to position **1**.

## 4.12 Lifting the sewing feet

The machine offers different ways to lift the sewing feet depending on its equipment:

- **ECO machines:** mechanically using the knee lever ( p. 61)
- **CLASSIC machines:** electropneumatically using the pedal ( p. 62)

### 4.12.1 Mechanical lifting with the knee lever

*Fig. 39: Mechanical lifting with the knee lever*



(1) - Knee lever



To lift the sewing feet mechanically using the knee lever (1):

1. Use your right knee to push the knee lever (1) to the right.
-  The sewing feet remain open while the knee lever (1) is pushed to the right.

## 4.12.2 Electropneumatic lifting with the pedal

Fig. 40: Electropneumatic lifting with the pedal

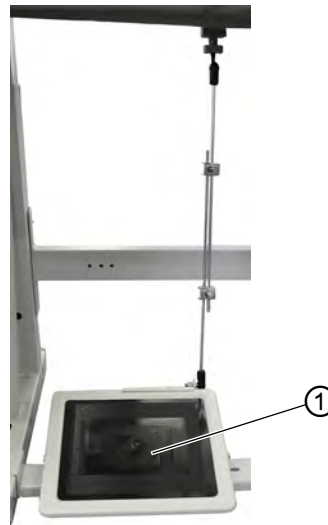

(1) - Pedal



To lift the sewing feet electropneumatically using the pedal:

1. Press the pedal (1) back to position -1.
  - ↳ The machine stops and lifts the sewing feet. The sewing feet remain up as long as the pedal (1) is pressed back in position -1.

or

1. Press the pedal (1) fully back to position -2.
  - ↳ The thread cutter is activated, and the sewing feet are raised.



## 4.13 Setting the sewing foot pressure

### NOTICE

#### **Property damage may occur!**

Damage to the sewing material.

Set the sewing foot pressure such that the sewing material is not pinched and does not have too much play.

Fig. 41: Setting the sewing foot pressure

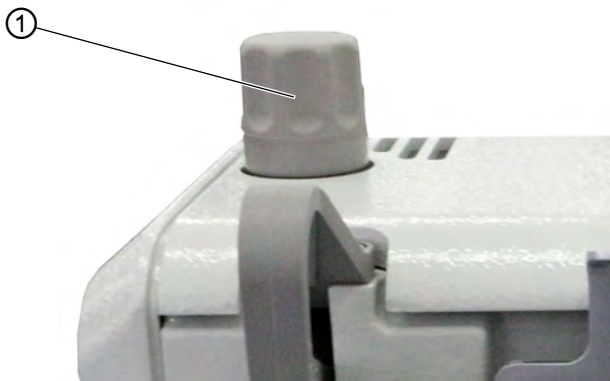

(1) - Adjusting wheel

The sewing foot pressure is set using the adjusting wheel (1).



To set the sewing foot pressure:

#### **Increasing the sewing foot pressure**

1. Turn the adjusting wheel (1) clockwise.

#### **Reducing the sewing foot pressure**

1. Turn the adjusting wheel (1) counterclockwise.





## 4.14 Buttons on the push button panel







Fig. 42: Buttons on the push button arm



The machine has push buttons on the machine arm which can be used to activate specific functions while sewing.

### Functions of the buttons

Button	Function
	<p><b>Sewing backwards</b> The machine sews in reverse while the button is pressed.</p>
	<p><b>Needle position</b> When this button is activated, the needle moves to a specific position. This position is determined individually via the parameter settings  p. 92. The machine comes configured so that selecting the button will bring the needle up.</p>
	<p><b>Start bartack/end bartack</b> This button cancels the general setting for sewing start and end bartacks. If start/end bartacks are on, pressing the button skips the next bartack. If start/ end bartacks are off, pressing the button sews the next bartack. For the general setting required for sewing start and end bartacks, refer to the  Instructions for use <i>DAC basic/classic</i>.</p>

Button	Function
	<p><b>Stitch length</b> When this function is active, the machine sews with the greater stitch length.</p>
	<p><b>Auxiliary thread tension</b> The auxiliary thread tension can be activated using this button.</p>
	<p><b>Pneumatic seam middle guide</b> The 6<sup>th</sup> button housed in the push button panel is either assigned the pneumatic seam middle guide or is fully customizable. If a pneumatic seam middle guide has been assembled to the machine, you can use this button to activate it  p. 77.</p>
	<p><b>Fully customizable</b> The button is fully customizable.</p>
	<p>This button is used to activate the left needle bar.</p>
	<p>This button is used to activate the right needle bar.</p>



### Information

The number of buttons and their functions vary with the equipment of the machine.

### 4.14.1 Switching on and off the function of a button

Fig. 43: Switching on and off the function of a button

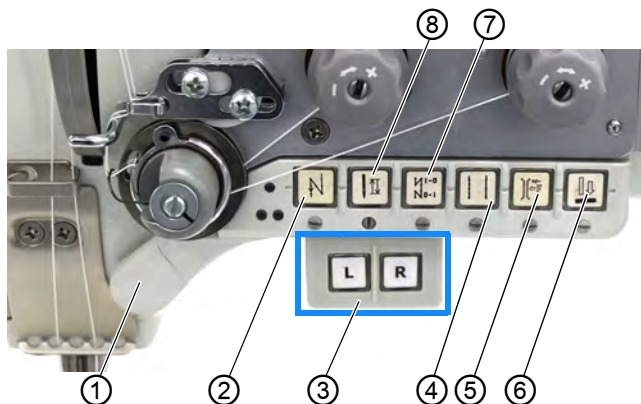

- |  |                                   |
|--|-----------------------------------|
| (1) - Favorite button                                    | (5) - Auxiliary thread tension    |
| (2) - Sewing backwards                                   | (6) - Pneumatic seam middle guide |
| (3) - Additional button (buttons <b>L</b> and <b>R</b> ) | (7) - Start bartack/end bartack   |
| (4) - Stitch length preselection                         | (8) - Needle position             |



To switch a function on and off:

#### Switching a function on

1. Press the desired button (1)/(2)/(3)/(4)/(5)/(6)/(7)/(8).
- ↳ The function is switched on. The pressed button lights up.

#### Switching a function off

1. Press the button (1)/(2)/(3)/(4)/(5)/(6)/(7)/(8) again.
- ↳ The function is switched off. The button you pressed is no longer lit.



#### Information

The additional button (3) is only found on 2-needle machines with switchable needle bars. You can use the buttons **L** and **R** to select if the left or the right needle bar is supposed to be activated (e.g. to sew around corners)

### 4.14.2 Assigning functions to the favorite button

You can assign one of the button functions to the favorite button. Select a function that you frequently use so that you can switch it on faster while sewing.

Fig. 44: Assigning a function to the favorite button

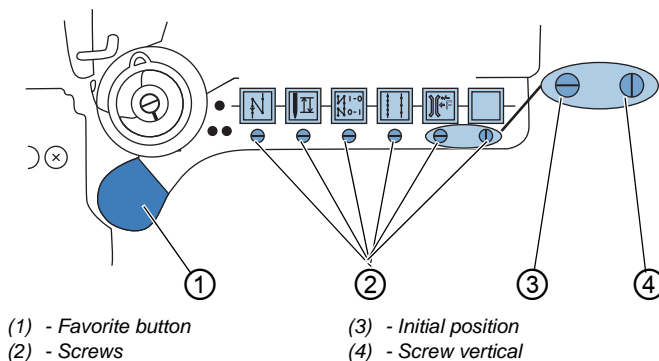

The button function is assigned by turning the screw (2) under the button until it is vertical. Only one function at a time can be assigned to the favorite button (1). Therefore, only one of the screws (2) may be in the vertical position (4).

All screws must be turned back to their horizontal initial position (3) before a new function is assigned.



To assign a function to the favorite button:

1. Turn all screws (2) to their initial position (3) so that the slots of the screws are horizontal.
2. Turn the screw (2) under the desired button 90° so that the slot is vertical (4).

## 4.15 LEDs on the machine arm

Fig. 45: LEDs on the machine arm

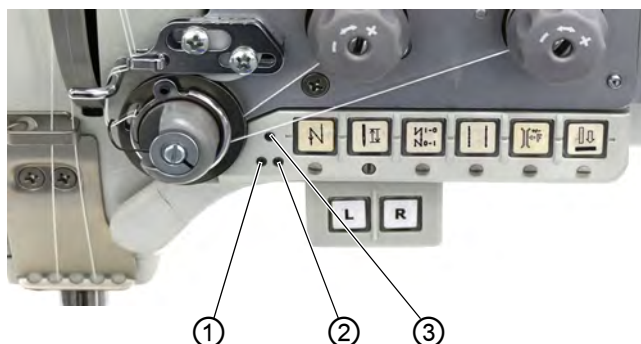

- (1) - LED (left remaining thread monitor)      (3) - LED  
 (2) - LED (right remaining thread monitor)

LED	Meaning
1	When the left LED is on, the remaining thread monitor signals that the bobbin in the left hook is almost empty.
2	When the right LED is on, the remaining thread monitor signals that the bobbin in the right hook is almost empty.
3	When on, the LED signals that the machine is switched on and not powered off.

## 4.16 Remaining thread monitor

### WARNING



#### Risk of injury from moving, cutting and sharp parts!

Crushing, cutting and punctures are possible.

Only change the hook bobbin with the machine switched off.

### Remaining thread monitor in action

Fig. 46: Remaining thread monitor in action (2)



(1) - Flat

(2) - Supply groove

Depending on the subclass of the machine, the hook may be fitted with a remaining thread monitor. The remaining thread monitor monitors the hook thread quantity on the bobbin inside the hook. If the light beam from the light barrier is reflected off the flat (1) on the bobbin core during sewing, the LED next to the push button panel on the machine arm comes on. This signals that the hook thread quantity is running low.

The remaining hook thread quantity will be sufficient to complete the seam and change the bobbin.



Proceed as follows when the remaining thread monitor signals the end of the hook thread:

1. Finish the seam you started.
-  The hook thread quantity in the supply groove (2) of the bobbin is usually sufficient to do so.

2. Press the pedal to position **-2** at the seam end (📖 p. 80).
  - ↳ The thread is cut off.
3. Remove the sewing material.

Fig. 47: Remaining thread monitor in action (4)

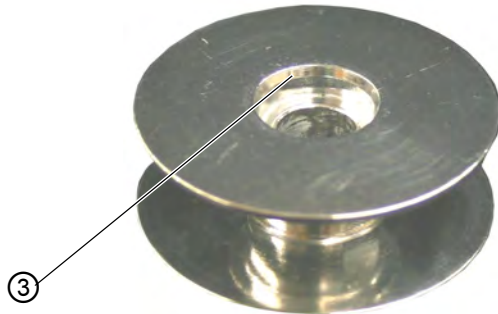

(3) - Milling groove



**Important**

Insert the new bobbin so that the milling groove (3) is facing down.



4. Changing the bobbin (📖 p. 44).
  - ↳ You can start sewing a new seam.
5. Take the remaining thread off the bobbin you removed.
6. If necessary, wind a new hook thread onto the empty bobbin (📖 p. 41).



## Cleaning the remaining thread monitor

### WARNING



#### **Risk of injury from moving, cutting and sharp parts!**

Crushing, cutting and punctures are possible.

Remove any lint from the bobbin case retainer and the light barrier.

Do not clean the lenses of the light barriers unless the machine is switched off.

Even the smallest remnants of fabric and yarn on its sensor will cause the remaining thread monitor to stop working properly. To ensure fault-free operation, you must clean the sensor of the remaining thread monitor using compressed air at least once a day ( p. 97).



To clean the remaining thread monitor:

1. Switch off the machine.
  2. Clean the lenses of the light barrier using compressed air.
-  The machine can be switched back on.

## 4.17 Sewing backwards with the stitch adjustment lever

The stitch adjustment lever on the machine arm reduces the stitch length down to sewing backwards in the lower end position.

Fig. 48: Sewing backwards with the stitch adjustment lever



(1) - Stitch adjustment lever



To sew backwards:

1. Slowly push the stitch adjustment lever (1) down.
  - ↳ The stitch length becomes smaller. In the lower end position, the machine sews backwards with the set stitch length.



### Information

To sew bartacks manually, press the stitch adjustment lever (1) down. The machine will sew backwards for as long as you keep down the stitch adjustment lever (1).

## 4.18 Stitch length

### 4.18.1 Setting the stitch length

#### NOTICE

##### Property damage may occur!

Machine can be damaged if the adjusting wheels are forced. The machine is designed in such a way that the stitch length at the top adjusting wheel cannot be set to a lower level than at the bottom adjusting wheel.

Do not attempt to force the top adjusting wheel to set a lower stitch length than at the bottom adjusting wheel.

#### NOTICE

##### Property damage may occur!

Risk of breakage.

The stitch length at adjusting wheel (2) must NOT be greater than the stitch length at adjusting wheel (3).

Fig. 49: Setting the stitch length



(1) - Marking

(2) - Adjusting wheel

(3) - Adjusting wheel

Depending on its subclass the machine is fitted with either 1 or 2 adjusting wheels for the adjustment of the stitch length. This makes it possible to sew different stitch lengths. The 2<sup>nd</sup> stitch length (adjusting wheel (3)) is activated using a button on the push button panel.



To set the stitch length:

### **Setting the stitch length on the adjusting wheel (2)**

1. Turn the adjusting wheel (2) counterclockwise until you reach the desired stitch length.

The marking (1) on the left of the adjusting wheel indicates the stitch length selected.

### **Setting the stitch length on the adjusting wheel (3)**

1. Turn the adjusting wheel (3) clockwise until you reach the desired stitch length.

The marking (1) on the left of the adjusting wheel indicates the stitch length selected.

### 4.18.2 Sewing with 2 stitch lengths

#### NOTICE

##### Property damage may occur!

Machine can be damaged if the adjusting wheels are forced. The machine is designed in such a way that the stitch length at the top adjusting wheel cannot be set to a lower level than at the bottom adjusting wheel.

Do not attempt to force the top adjusting wheel to set a lower stitch length than at the bottom adjusting wheel.

#### NOTICE

##### Property damage may occur!

Risk of breakage.

The stitch length at adjusting wheel (2) must not be greater than the stitch length at adjusting wheel (3).

Fig. 50: Sewing with 2 stitch lengths

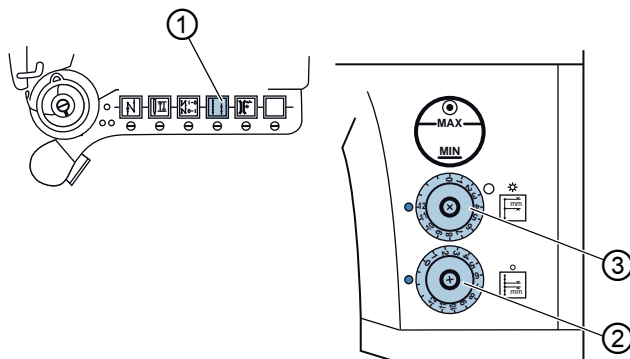

(1) - Button  
(2) - Adjusting wheel

(3) - Adjusting wheel

Depending on its subclass the machine is fitted with 2 adjusting wheels for the adjustment of the stitch length. These can be used to sew two different stitch lengths and can be activated with a press of button (1).

The stitch lengths are set using the adjusting wheels (2) and (3).

### 4.18.3 Removing blocking of the adjusting wheels

#### WARNING



**Risk of injury from moving, cutting or sharp parts!**

Crushing, cutting and punctures are possible.

Switch off the machine before you remove the blocking of the adjusting wheels.

Machines with blockable adjusters are used especially in the automotive sector. With these machines the blocking must be removed before the stitch length can be adjusted.

Fig. 51: Removing blocking of the adjusting wheels

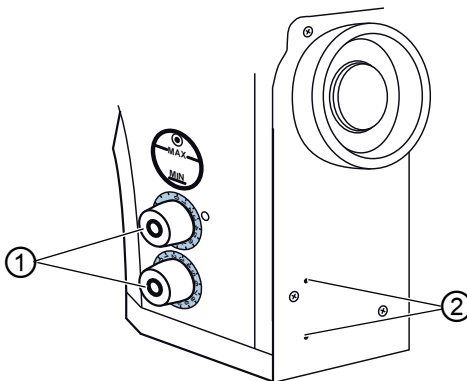

(1) - Adjusting wheel

(2) - Access hole



To remove the blocking of the adjusting wheels:

1. Insert a 3 mm hex key through the access holes (2) and release the blocking screws for the adjusting wheels (1).
2. Set the adjusting wheels (1) again (📖 p. 73).
3. Insert a 3 mm hex key through the access holes (2) and tighten the blocking screws for the adjusting wheels (1).

## 4.19 Additional equipment seam middle guide

### NOTICE

#### **Property damage may occur!**

Damage to the sewing material and the seam middle guide.

Set a maximum of 3 bar for the seam middle guide at the pressure controller.

The seam middle guide on 2-needle machines is used as an aid to guide the material during top stitching.

The guide piece is intended to maintain the seam center, keeping the distance of the seam center to the left and the right needle exactly the same.

The seam middle guide can be activated/deactivated using a button on the push button panel ( p. 64).

There are 2 versions of the seam middle guide:

*Fig. 52: Additional equipment seam middle guide (1)*

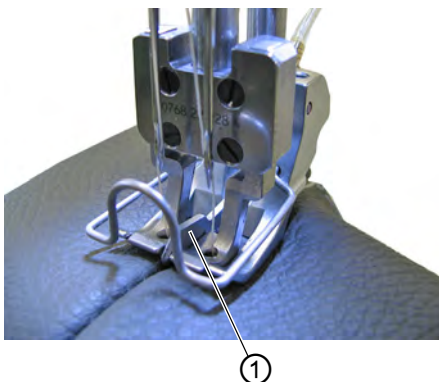

(1) - Seam middle guide

Fig. 53: Additional equipment seam middle guide (2)



(2) - Seam middle guide

To keep the seam middle guide (1)/(2) from leaving marks or damaging the sewing material, the maximum operating pressure must not exceed 3 bar.



Fig. 54: Additional equipment seam middle guide (3)

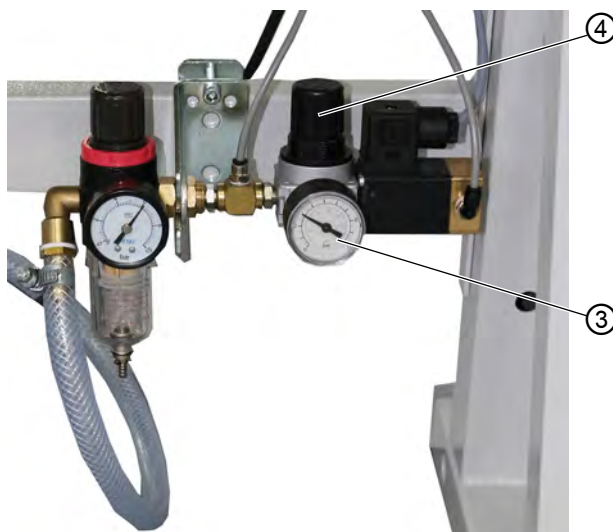

(3) - Pressure gage

(4) - Pressure controller

### Increasing the contact pressure



To increase the contact pressure of the seam middle guide (1)/(2):

1. Pull the pressure controller (4) up.
2. Turn the pressure controller (4) clockwise until the pressure gage (3) indicates the proper setting.
3. Push the pressure controller (4) down.

### Reducing the contact pressure



To reduce the contact pressure of the seam middle guide (1)/(2):

1. Pull the pressure controller (4) up.
2. Turn the pressure controller (4) counterclockwise until the pressure gage (3) indicates the proper setting.
3. Push the pressure controller (4) down.

## 4.20 Sewing

### 4.20.1 Pressing the pedal

#### WARNING



#### Risk of injury from moving parts!

Crushing injuries may be sustained while lowering the sewing feet.

Do NOT put your hands under the lifted sewing feet.

Fig. 55: Pressing the pedal

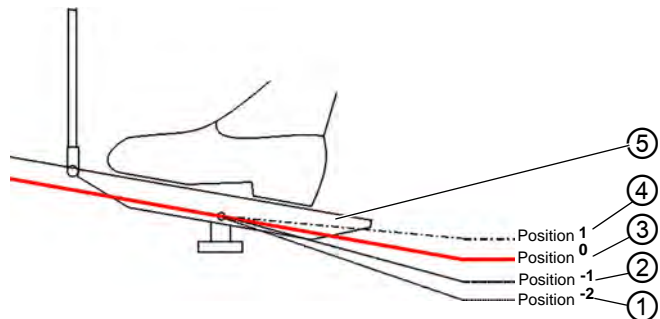

- |  |                     |
|--|---------------------|
| (1) - Sew end bartack and cut off thread | (3) - Rest position |
| (2) - Lift sewing foot                   | (4) - Sewing active |
|  | (5) - Pedal         |

#### Initial situation

- Pedal in position 0:

✎ The machine is at a standstill, the needle is up, and the sewing feet are down.

#### Positioning the sewing material



To position the sewing material:

1. Press the pedal (5) halfway back to position -1:  
✎ The sewing feet are lifted.
2. Push the sewing material into the initial position.

## Sewing



To sew:

1. Press the pedal (5) forward to position **1**.



The machine sews.

The sewing speed increases the further forward the pedal (5) is pressed.

## Interrupting sewing



To interrupt sewing:

1. Release the pedal (5) (position **0**).



The machine stops, and needle and sewing feet are down.

## Continue sewing



To continue sewing:

1. Press the pedal (5) forward to position **1**.



The machine continues to sew.

## Sewing over thicker parts of the sewing material



To sew over thicker parts of the sewing material:

1. Switch on the increased sewing foot stroke with the knee button ( p. 60).

## Changing the stitch length



To change the stitch length:

1. 2<sup>nd</sup> stitch length must be switched on using the quick function button ( p. 75).

## Increasing the thread tension



To increase the thread tension:

1. Switch on the additional tensioner using the quick function button ( p. 51).

### Sewing an intermediate bartack



To sew an intermediate bartack:

1. Reverse sewing with the stitch adjustment lever or the quick function button ( p. 64).

### Finishing the seam



To finish the seam:

1. Press the pedal (5) fully back to position -2:
  - ↳ The machine sews the end bartack, and the thread cutter cuts the thread.  
The machine stops, and needle and sewing feet are up.
2. Remove the sewing material.

### 4.20.2 Sewing with the machine

The following is an example of how to sew with one of the machines.

To complete the operating steps listed below, a CLASSIC machine must possess the following features:

- 1-needle machine
- Thread cutter
- electropneumatic seam bar tacking and sewing foot lift
- electropneumatic quick stroke adjustment

The following functions have been set at the control panel:

Function	Setting
Start bartack:	ON
End bartack:	ON
Sewing foot position before and after cutting:	DOWN
Needle position before cutting:	DOWN (pedal in 1 <sup>st</sup> position = pedal in position <b>0</b> )
Needle position after cutting:	UP (pedal in 2 <sup>nd</sup> position = pedal in position <b>-2</b> )

The last sewing process is completed with an end bartack and by cutting off the thread.



To sew with the machine:

#### Preparing to sew

1. Switch on the machine ( p. 20).
  - ↳ The needle is up, and the sewing feet are down. The pedal is in position **0**. The machine is ready for operation.
2. Press the pedal back to position **-1**.
  - ↳ Lift the sewing feet.
3. Place the sewing material at the appropriate position above the throat plate.

### Beginning to sew

4. To start sewing, press the pedal forward to position **1**.
- ↳ The machine sews the set start bartack with the programmed number of stitches. Next, the machine keeps sewing at the speed set by pressing the pedal. The speed increases the further you press the pedal forward.

### Interrupting sewing

5. To interrupt the sewing process, release the pedal (position **0**).
- ↳ The machine stops in the 1st position, i.e. with the needle and the sewing feet at the bottom position.
6. To resume the sewing process, press the pedal forward to position **1**.

### Sewing an intermediate bartack

Fig. 56: Sewing with the machine (1)

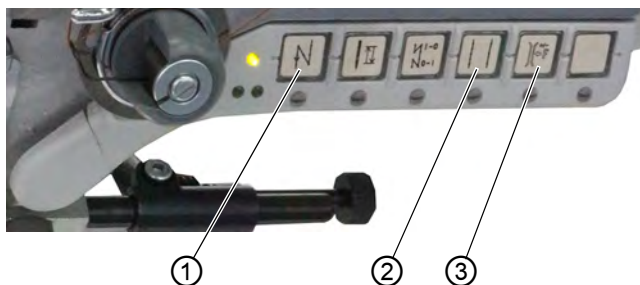

- |   |  |
|---|--|
| (1) - Button (sewing in reverse)                | (3) - Button (activate auxiliary thread tension) |
| (2) - Button (switching over the stitch length) |  |

Fig. 57: Sewing with the machine (2)

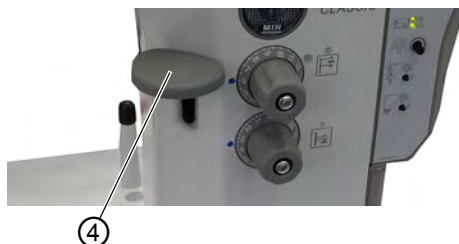

- (4) - Stitch adjustment lever

7. To sew an intermediate bartack, press button (1)  
OR  
Push the stitch adjustment lever (4) down.
- ✎ The machine will sew in reverse for as long as you keep down the button (1) or the stitch adjustment lever (4) ( p. 72). Afterwards, the machine keeps sewing at the speed set by pressing the pedal.

### Using the 2<sup>nd</sup> stitch length

8. To use the 2<sup>nd</sup> (maximum) stitch length during sewing, press button (2) ( p. 75).
9. To switch back to the normal stitch length, press button (2) again.

### Increasing the thread tension

10. To increase the additional tension during sewing, press button (3) ( p. 51).
11. To switch back to the normal needle thread tension, press button (3) again.

### Sewing over cross seams

Fig. 58: Sewing with the machine (3)

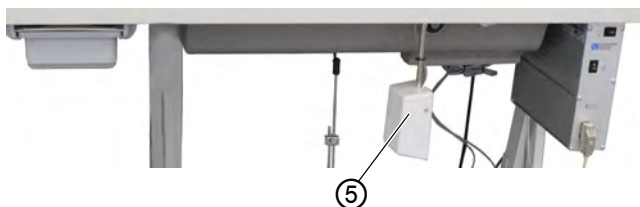

(5) - Knee button

12. To sew over thick places in the material such as cross seams, activate the maximum sewing foot stroke using the knee button (5).
- ✎ Depending on whether the knee button (5) is operated in push-to-run or hold-to-run mode, press the knee button (5) once or press it and hold it down ( p. 60).
13. To switch the increased sewing foot stroke off, press the knee button (5) again  
OR  
stop holding it down.

**Finishing the seam**

14. Press the pedal to position **-2** and keep it there.
  - ↳ If activated, the machine will sew the end bartack.  
The thread is cut off.  
The machine stops in the 2<sup>nd</sup> position.  
The needle and the sewing feet are up.
15. Remove the sewing material.



## 5 Programming

ECO machines come with a control integrated into the machine head, but do not have a control panel.

All CLASSIC machines are equipped with a control, housed below the tabletop, and the control panel OP1000 found at the machine head.

Fig. 59: Programming

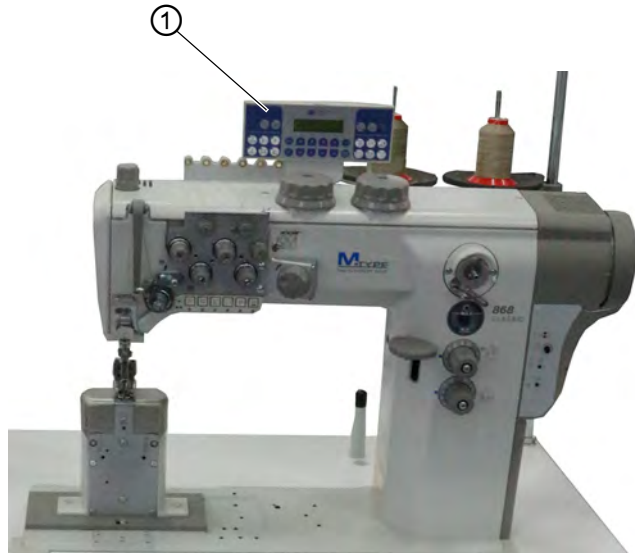

(1) - Control panel OP1000

All settings are performed using this control panel.

The control panel is composed of a display and buttons.

Using the control panel you can:

- Use groups of buttons to select machine functions
- Read service and error messages



### Information

This chapter describes the machine-specific functions of the OP1000 control panel.

Refer to the  *Instructions for use DAC basic/classic* for further information on the control of the CLASSIC machines and the OP1000 control panel.

For further information on the control built into the ECO machines, refer to the  *Instructions for use DAC eco*.



## 5.1 Buttons on the control panel

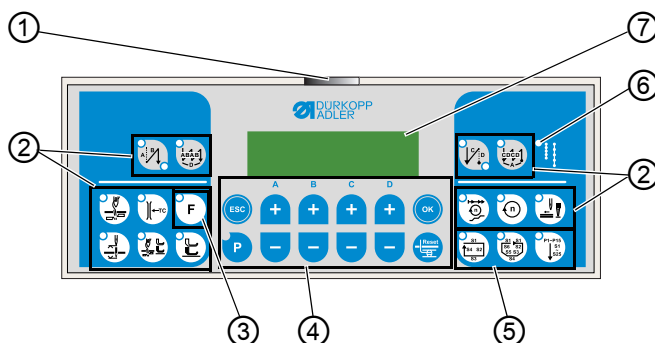









Fig. 60: Buttons on the control panel

















- |                                |                                 |
|--------------------------------|---------------------------------|
| (1) - Power LED                | (5) - Seam program button group |
| (2) - Thread button group      | (6) - LED for 2nd Stitch length |
| (3) - Function button          | (7) - Display                   |
| (4) - Programming button group |                                 |

### OP1000 buttons and functions

Button	Function
<b>Thread button group</b>	
 Start bartack	<ul style="list-style-type: none"> <li>• Sets the start bartack</li> </ul>
 Multiple start bartack	<ul style="list-style-type: none"> <li>• Sets the multiple start bartack</li> </ul>

Button	Function
	<p>End bartack</p> <ul style="list-style-type: none"> <li>• Sets the end bartack</li> </ul>
	<p>Multiple end bartack</p> <ul style="list-style-type: none"> <li>• Sets the multiple end bartack</li> </ul>
	<p>Thread cutter</p> <ul style="list-style-type: none"> <li>• Activates or deactivates the thread cutter</li> </ul>
	<p>Thread clamp</p> <ul style="list-style-type: none"> <li>• Activates or deactivates the thread clamp</li> </ul>
	<p>Needle position after sewing stop</p> <ul style="list-style-type: none"> <li>• Sets the needle position after sewing stop</li> </ul>
	<p>Sewing foot lift after thread cutter</p> <ul style="list-style-type: none"> <li>• Activates or deactivates the sewing foot lift after the thread cutter</li> </ul>
	<p>Sewing foot lift after sewing stop</p> <ul style="list-style-type: none"> <li>• Activates or deactivates the sewing foot lift after sewing stops</li> </ul>
	<p>Soft start</p> <ul style="list-style-type: none"> <li>• Activates or deactivates the soft start</li> </ul>
	<p>Speed</p> <ul style="list-style-type: none"> <li>• Reduces the motor speed</li> </ul>
	<p>Function button</p> <ul style="list-style-type: none"> <li>• Activates or deactivates any stored function</li> </ul>

Button	Function
<b>Programming button group</b>	
 ESC	<ul style="list-style-type: none"> <li>• Ends parameter mode</li> </ul>
 A+	<ul style="list-style-type: none"> <li>• Increases parameter</li> <li>• Changes user level</li> <li>• Selects subprogram</li> </ul>
 B+	<ul style="list-style-type: none"> <li>• Increases parameter</li> <li>• Changes to next higher category</li> <li>• Selects subprogram</li> </ul>
 C+	<ul style="list-style-type: none"> <li>• Increases parameter</li> <li>• Selects subprogram</li> </ul>
 D+	<ul style="list-style-type: none"> <li>• Increases parameter</li> <li>• Selects subprogram</li> </ul>
 OK	<ul style="list-style-type: none"> <li>• Calls parameter or saves it</li> </ul>
 P	<ul style="list-style-type: none"> <li>• Starts or ends the parameter mode</li> </ul>
 A-	<ul style="list-style-type: none"> <li>• Decreases parameter</li> <li>• Changes user level</li> <li>• Selects subprogram</li> </ul>

Button	Function
	<ul style="list-style-type: none"> <li>Decreases parameter</li> <li>Changes to next lower category</li> <li>Selects subprogram</li> </ul>
	<ul style="list-style-type: none"> <li>Decreases parameter</li> <li>Selects subprogram</li> </ul>
	<ul style="list-style-type: none"> <li>Decreases parameter</li> <li>Selects subprogram</li> </ul>
	<ul style="list-style-type: none"> <li>Resets the (piece) counter</li> </ul>
<b>Seam program button group</b>	
	<ul style="list-style-type: none"> <li>Activates seam program I</li> </ul>
	<ul style="list-style-type: none"> <li>Activates seam program II</li> </ul>
	<ul style="list-style-type: none"> <li>Sets seam program III</li> </ul>

## 5.2 Assigning functions to buttons on the push button panel

Fig. 61: Assigning functions to buttons on the push button panel







The buttons on the push button panel can be assigned different functions. Possible function assignments are, for instance:

- Suppress stitch condensing
- Single stitch
- Needle up/down
- Stroke adjustment



To assign a function to a button on the push button panel:

1. Press the  button.
2. Press and hold the button on the push button panel to which you wish to assign a function.
  - ↳ The control panel shows the value currently set for the button.
3. Use +/- to enter the desired value ( *Parameter list 868*).
4. Confirm with  .
5. Press the  button.
  - ↳ The machine is ready to sew again.

### 5.3 Assigning a function to the knee button

Fig. 62: Assigning a function to the knee button



(1) - Toggle switch

(2) - Knee button

The knee button (2) can be assigned 2 different functions. The functions are selected in sewing mode via the position of the toggle switch (1) (**1** or **0**).



#### Information

At the factory, the knee button was assigned the switchable sewing foot stroke function in push-to-run and hold-to-run mode ( p. 60).

The knee button (2) can also be assigned different functions.



To assign a function to the knee button (2):

1. Press the  button.
2. Set the toggle switch (1) to the desired position (**1** or **0**).  
If the toggle switch (1) is, for instance, set to the bottom position, the new function is saved to the **0** position.

3. Keep the knee button (2) pressed for a few seconds.

  flashes.

The display shows a numerical value.

4. Use the buttons + or - to set the numerical value to the desired value associated with the new function ( *Parameter list 868*).

5. Confirm with  .



## 6 Maintenance

### WARNING



#### **Risk of injury from sharp parts!**

Punctures and cutting possible.

Prior to any maintenance work, switch off the machine or set the machine to threading mode.

### WARNING



#### **Risk of injury from moving parts!**

Crushing possible.

Prior to any maintenance work, switch off the machine or set the machine to threading mode.

This chapter describes maintenance work that needs to be carried out on a regular basis to extend the service life of the machine and achieve the desired seam quality.

Advanced maintenance work may only be carried out by qualified specialists ( *Service Instructions*).

**Maintenance intervals**

Work to be carried out	Operating hours			
	8	40	160	500
<b>Cleaning</b>				
Removing lint and thread remnants	●			
<b>Lubricating</b>				
Checking the oil level	●			
Checking the hook lubrication		●		
<b>Servicing the pneumatic system</b>				
Setting the operating pressure	●			
Check the water level in the pressure controller		●		
Draining the water condensation	●			
Cleaning the filter element				●
Check the tightness of the system				●

## 6.1 Cleaning

### WARNING



#### **Risk of injury from flying particles!**

Flying particles can enter the eyes, causing injury.

Wear safety goggles.

Hold the compressed air gun so that the particles do not fly close to people.

Make sure no particles fly into the oil pan.

### NOTICE

#### **Property damage from soiling!**

Lint and thread remnants can impair the operation of the machine.

Clean the machine as described.

If very fluffy sewing material is being sewn, the machine must be cleaned more frequently.

### NOTICE

#### **Property damage from solvent-based cleaners!**

Solvent-based cleaners will damage paintwork.

Use only solvent-free substances for cleaning.

Fig. 63: Cleaning (1)

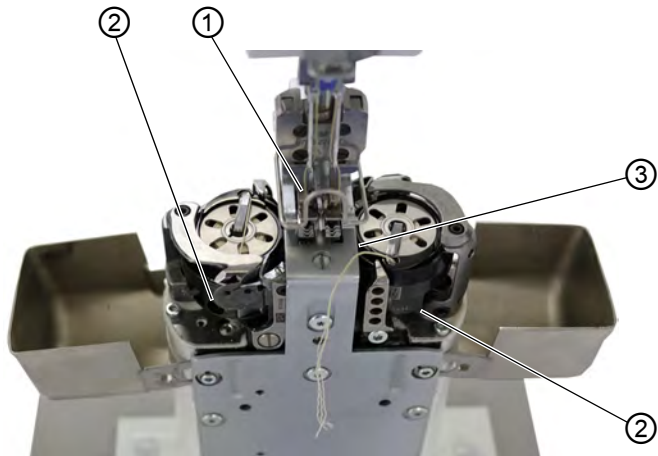

- (1) - Area around the needle(s)      (3) - Area under the throat plate  
(2) - Area around the hook

Fig. 64: Cleaning (2)

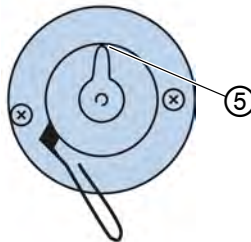

- (4) - Cutter on the winder

**Areas particularly susceptible to soiling:**

- Area around the needle (1)
- Area around the hook (2)
- Area under the throat plate (3)
- Sensor of the remaining thread monitor
- Cutter on the winder for the hook thread (4)

**Cleaning steps:**

1. Switch off the machine ( p. 20).
2. Remove any lint and thread remnants using a compressed air gun or a brush.

## 6.2 Lubricating

**CAUTION****Risk of injury from contact with oil!**

Oil can cause a rash if it comes into contact with skin.

Avoid skin contact with oil.

If oil has come into contact with your skin, wash the affected areas thoroughly.

**NOTICE****Property damage from incorrect oil!**

Incorrect oil types can result in damage to the machine.

Only use oil that complies with the data in the instructions.

**CAUTION****Risk of environmental damage from oil!**

Oil is a pollutant and must not enter the sewage system or the soil.

Carefully collect up used oil.

Dispose of used oil and oily machine parts in accordance with national regulations.

The machine is equipped with a central oil-wick lubrication system. The bearings are supplied from the oil reservoir.

For topping off the oil reservoir, use only lubricating oil **DA 10** or oil of equivalent quality with the following specifications:

- Viscosity at 40 °C: 10 mm<sup>2</sup>/s
- Flash point: 150 °C

You can order the lubricating oil from our sales offices using the following part numbers.

Container	Part no.
250 ml	9047 000011
1 l	9047 000012
2 l	9047 000013
5 l	9047 000014

## 6.2.1 Checking the oil level



### Proper setting

The oil level is between the minimum level marking and the maximum level marking.

Fig. 65: Checking the oil level (1)

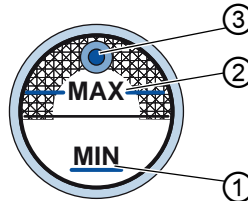

(1) - Minimum level marking  
(2) - Maximum level marking

(3) - Refill opening



To check the oil level:

1. Check the oil level indicator at the inspection glass every day.

**Classic machines:** If the lamp behind the inspection glass lights up red, the machine is not sufficiently supplied with oil.

Fig. 66: Checking the oil level (2)



2. If the oil level is below the minimum level marking (1): Pour oil through the refill opening (3) but no higher than the maximum level marking (2).



### Important

The lamp behind the inspection glass will not go out until the oil has been topped off and the machine was switched off and back on again (📖 p. 20).

## 6.2.2 Setting the hook lubrication

### CAUTION



#### Risk of injury!

Crushing and puncture possible.

Only lubricate the hook when the machine is switched off. Carry out function tests with utmost caution when the sewing machine is switched on.

The approved oil quantity for hook lubrication is a factory specification.



#### Proper setting

To check the hook lubrication:

1. Hold a piece of blotting paper next to the hook.
  2. Allow the machine to run without thread and sewing material for 10 seconds with the sewing feet lifted and at a high speed.
- ↳ The blotting paper will show a thin strip of oil when sewing is complete.

Fig. 67: Setting the hook lubrication

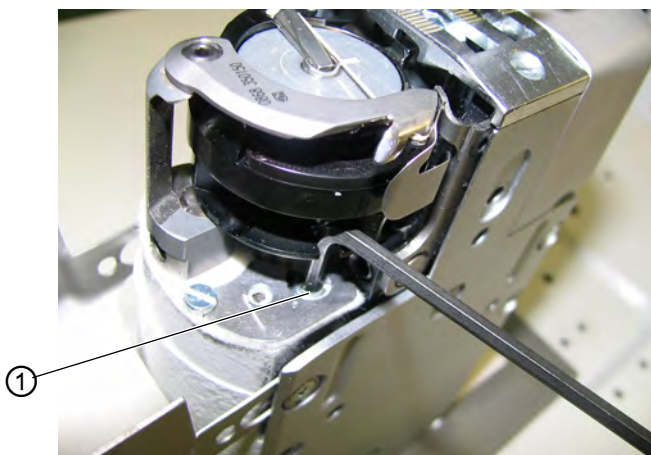

(1) - Screw





To set the hook lubrication:

1. Turn the screw (1):
  - counterclockwise: more oil is released
  - clockwise: less oil is released



### **Important**

The released amount of oil does not change until the operating time has run a few minutes. Sew for several minutes before you check the setting again.



### **Information**

The right and the left hook are designed in exactly the same way, but they are mirror images of each other.

---

## 6.3 Servicing the pneumatic system

### 6.3.1 Setting the operating pressure

#### NOTICE

##### Property damage from incorrect setting!

Incorrect operating pressure can result in damage to the machine.

Ensure that the machine is only used when the operating pressure is set correctly.



#### Proper setting

Refer to the **Technical data** (📖 p. 149) chapter for the permissible operating pressure. The operating pressure cannot deviate by more than  $\pm 0.5$  bar.

Check the operating pressure on a daily basis.

Fig. 68: Setting the operating pressure

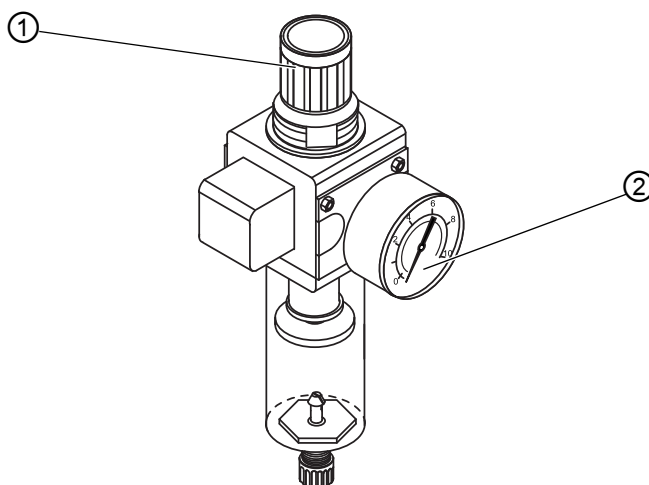

(1) - Pressure controller

(2) - Pressure gage



To set the operating pressure:

1. Pull the pressure controller (1) up.
2. Turn the pressure controller until the pressure gage (2) indicates the proper setting:
  - Increase pressure = turn clockwise
  - Reduce pressure = turn counterclockwise
3. Push the pressure controller (1) down.

### 6.3.2 Draining the water condensation

#### NOTICE

##### Property damage from excess water!

Excess water can cause damage to the machine.

Drain water as required.

Water condensation accumulates in the water separator (2) of the pressure controller.



##### Proper setting

Water condensation must not rise up to the level of the filter element (1).

Check the water level in the water separator (2) on a daily basis.

Fig. 69: Draining the water condensation

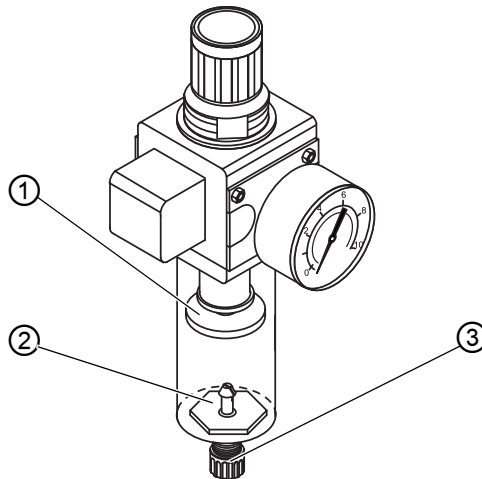

(1) - Filter element  
(2) - Water separator

(3) - Drain screw



To drain water condensation:

1. Disconnect the machine from the compressed air supply.
2. Place the collection tray under the drain screw (3).
3. Loosen the drain screw (3) completely.
4. Allow water to drain into the collection tray.

5. Tighten the drain screw (3).
6. Connect the machine to the compressed air supply.

### 6.3.3 Cleaning the filter element

#### NOTICE

#### **Damage to the paintwork from solvent-based cleaners!**

Solvent-based cleaners damage the filter.

Use only solvent-free substances for washing out the filter tray.

Fig. 70: Cleaning the filter element

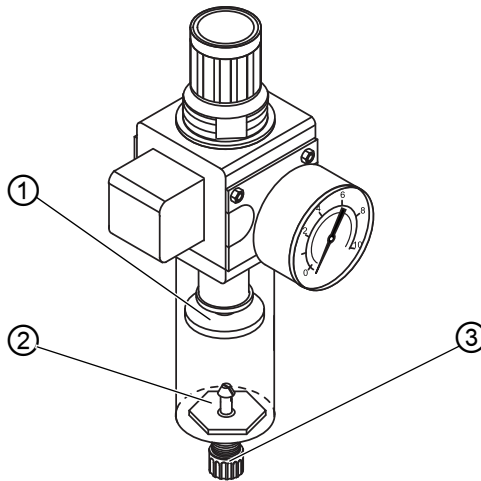

(1) - Filter element  
(2) - Water separator

(3) - Drain screw



To clean the filter element:

1. Disconnect the machine from the compressed air supply.
2. Drain the water condensation ( p. 106).
3. Loosen the water separator (2).
4. Loosen the filter element (1).
5. Blow out the filter element (1) using the compressed air gun.

6. Wash out the filter tray using benzine.
7. Tighten the filter element (1).
8. Tighten the water separator (2).
9. Tighten the drain screw (3).
10. Connect the machine to the compressed air supply.

## **6.4 Parts list**

A parts list can be ordered from Dürkopp Adler. Or visit our website for further information at:

[www.duerkopp-adler.com](http://www.duerkopp-adler.com)



## 7 Setup

### WARNING



#### **Risk of injury from cutting parts!**

Cutting injuries may be sustained while unpacking and setting up the machine.

Only qualified specialists may set up the machine.  
Wear safety gloves

### WARNING



#### **Risk of injury from moving parts!**

Crushing injuries may be sustained while unpacking and setting up the machine.

Only qualified specialists may set up the machine.  
Wear safety shoes.

### 7.1 Checking the scope of delivery

The scope of delivery depends on your specific order.

Check that the scope of delivery is correct after taking delivery.

### 7.2 Removing the transport locks

Remove all transport locks before setting up the machine:

- Lashing straps and wooden blocks from the machine head
- If applicable, lashing straps and wooden blocks from the tabletop and the stand
- If applicable, restraint block and straps from the sewing motor
- All pieces of Styrofoam and cardboard

## 7.3 Assembling the stand

Fig. 71: Assembling the stand

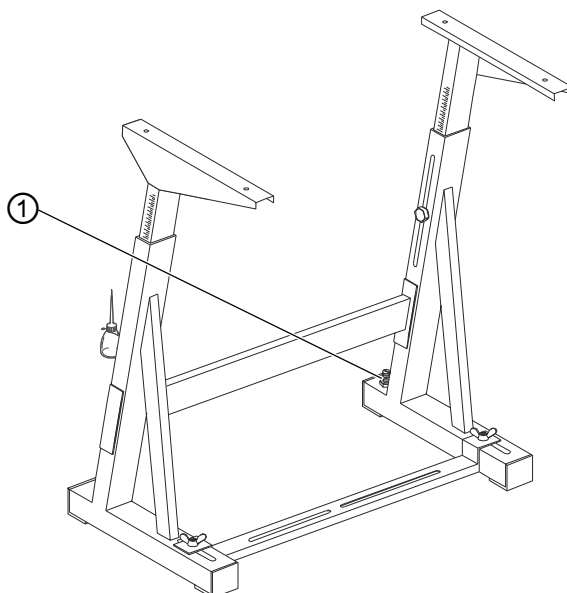

(1) - Adjusting screw



To assemble the stand:

1. Assemble the stand as shown in the figure.
2. **Important:** Turn the adjusting screw (1) so that the stand has even contact with the ground.



### Information

The working height can be set at the stand ( p. 122).



## 7.4 Assembling the control

The control used for ECO machines is built into the motor cover. CLASSIC machines require that the DAC classic control be assembled under the tabletop.

Fig. 72: Assembling the control

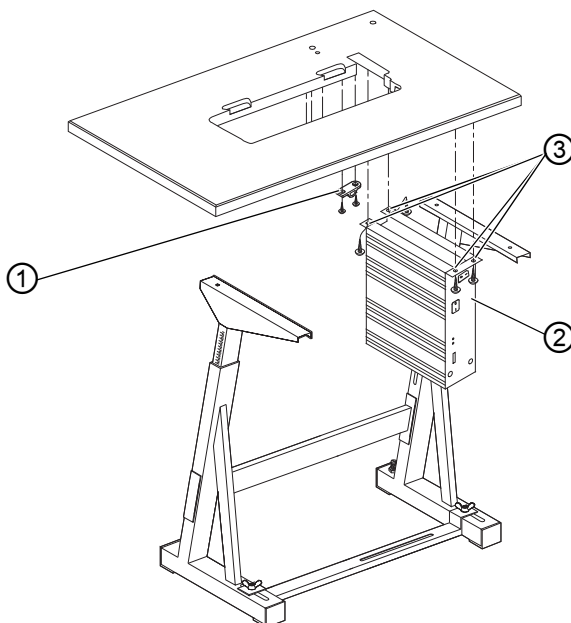

(1) - Strain relief mechanism  
(2) - Control

(3) - Screw holder



To assemble the control:

1. Screw the control (2) onto the 4 screw holders (3) under the tabletop.
2. Clamp the power cable of the control (2) into the strain relief mechanism (1).
3. Screw the strain relief mechanism (1) in place under the tabletop using 2 screws.

## 7.5 Completing the tabletop

To complete the tabletop, you must assemble the tilt protection device, the drawer, the oil pan, the reel stand and the protection parts.

Fig. 73: Completing the tabletop (1)

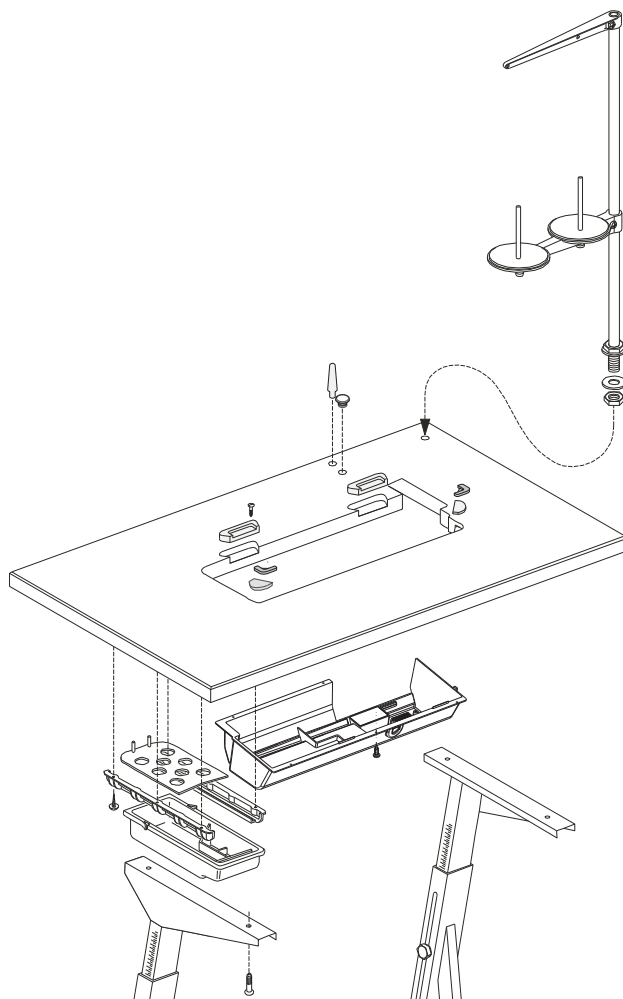

Ensure that the tabletop has sufficient load-bearing capacity and strength. If you want to make your own tabletop, use the dimensions given in the tabletop drawing as a template. You will find the drawing in the **Appendix** ( p. 160).

*Fig. 74: Completing the tabletop (2)*

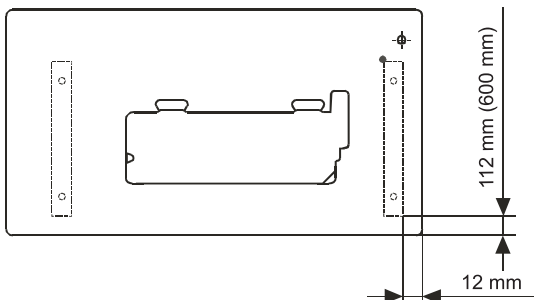

### Drawer and oil pan

*Fig. 75: Completing the tabletop (3)*



(1) - Drawer

(2) - Oil pan



To assemble the drawer and the oil pan:

1. Assemble the drawer (1) on the left under the tabletop.
  2. Assemble the oil pan (2) under the tabletop.
-  The stand must be assembled between the drawer (1) and the oil pan (2).

## Protection parts

Fig. 76: Completing the tabletop (4)

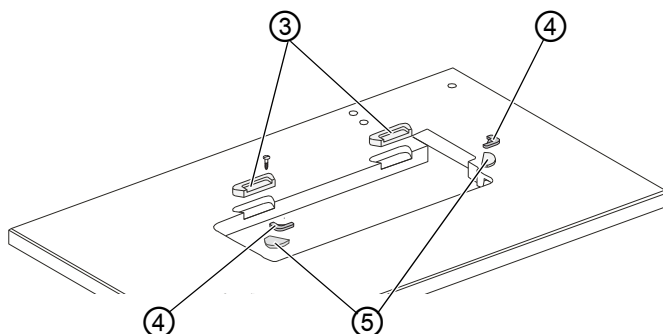

(3) - Lower hinge part

(4) - Plastic shim

(5) - Rubber corners

The rubber corners (5) serve the following functions:

- Protecting the tabletop and the machine head
- Ensuring that the machine head is securely seated in the tabletop cutout



### Information

The plastic shims (4) are not required unless the machine head is supposed to be set up in a slanted position (📖 p. 119).

Do NOT insert the plastic shims (4) if the machine head is supposed to be set up straight inside the tabletop cutout.



To prepare the tabletop cutout for the machine head:

1. Insert the plastic shims (4) into the front corners inside the tabletop cutout if the machine is supposed to be set up in a slanted position.  
The tall edge must face towards the rear, while the flat edge must face forward.
2. Insert the rubber corners (5) into the front corners in the tabletop cutout.
3. Insert the lower hinge parts (3) into the hinge slots in the tabletop cutout on the rear left and right.

## Tilt protection device

Fig. 77: Completing the tabletop (5)

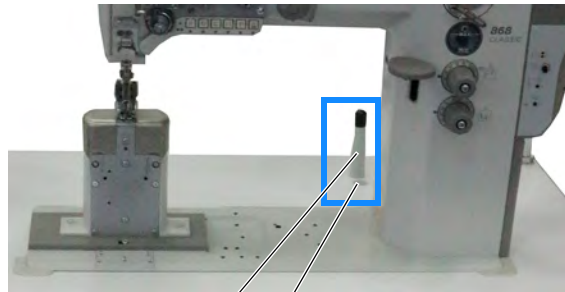

(6) - Tilt protection device

(7) - Plug



To assemble the tilt protection device:

1. Assemble the tilt protection device (6) in the designated slot of the tabletop.
2. Screw the plug (7) into the designated slot of the tabletop.

## Reel stand

Fig. 78: Completing the tabletop (6)

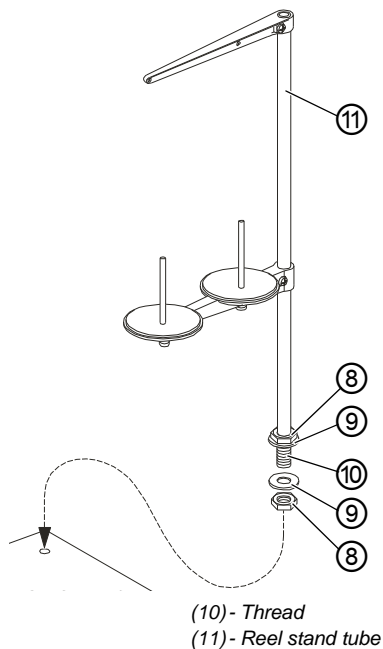

### Information

The reel stand shown belongs to a 1-needle machine. The reel stand on 2-needle machines is fitted with a 2nd thread reel holder with 2 additional plates for the hook thread reel.



To assemble the reel stand:

1. Place a washer (9) onto the hole in the tabletop.
2. Screw in a nut (8) until you reach the end of the thread (10).
3. Insert the reel stand tube (11) through the washer (9) and into the hole in the tabletop.
4. Slip the 2<sup>nd</sup> washer (9) from the bottom onto the thread (10).

5. Screw a second nut (8) from the bottom onto the thread at the end of the reel stand tube (11).
- ↳ The reel stand is now securely assembled to the tabletop.

## 7.6 Assembling the pedal and setpoint device

Fig. 79: Assembling the pedal and setpoint device (1)

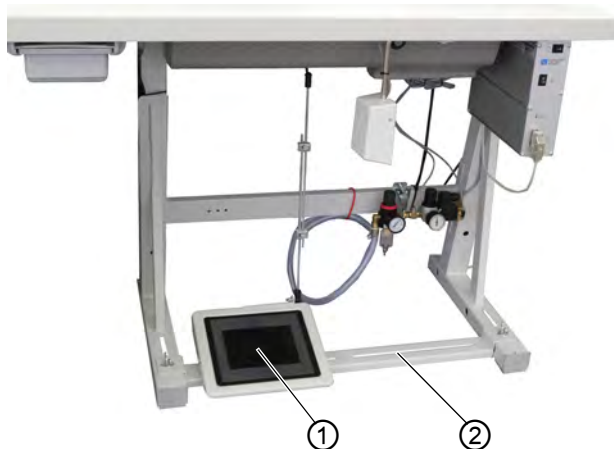

(1) - Pedal

(2) - Cross strut



To assemble the pedal:

1. Fit the pedal (1) on the cross strut (2) and align it in such a way that the middle of the pedal is under the needle.
2. Tighten the pedal (1) on the cross strut (2).

Fig. 80: Assembling the pedal and setpoint device (2)

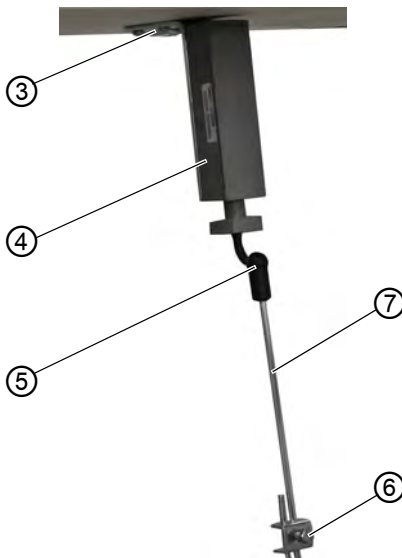

- (3) - Bracket
- (4) - Setpoint device
- (5) - Ball joints

- (6) - Screw
- (7) - Pedal rod



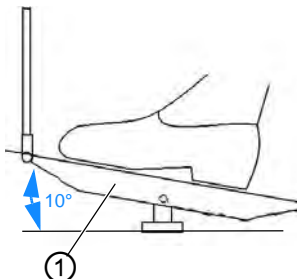

3. Screw the bracket (3) under the tabletop so that the pedal rod (7) runs to the pedal (1) at right-angles to the setpoint device (4).
4. Screw the setpoint device (4) onto the bracket (3).
5. Attach the pedal rod (7) with the ball joints (5) to the setpoint device (4) and to the pedal (1).
6. Slightly loosen the screw (6).

Fig. 81: Assembling the pedal and setpoint device (3)





-  7. Pull the pedal rod (7) to the correct length:
-  **Proper setting:** 10° inclination with pedal (1) released.
- 8. Tighten the screw (6).

## 7.7 Inserting the machine head

### WARNING



#### **Risk of crushing from moving parts.**

The machine head is very heavy.  
Crushing possible.

Ensure that your hands are not jammed when  
inserting the machine head.

### NOTICE

#### **Property damage may occur!**

Cable may sustain damage and impair the operation of the  
machine.

Always lay the cables so as not to create any chafing or  
pinching points.

Fig. 82: Inserting the machine head (1)

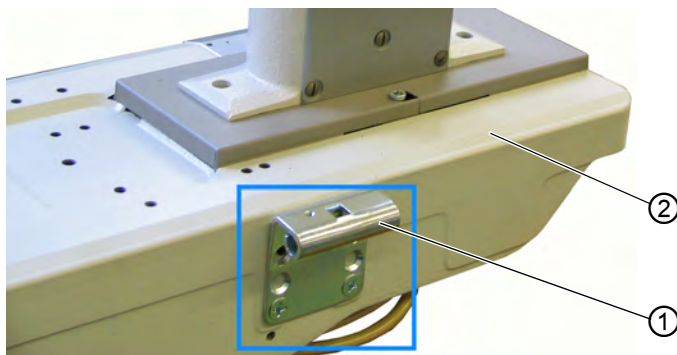

(1) - Hinge

(2) - Machine head



To insert the machine head (2):

1. Tighten the hinges (1) at the rear of the machine head (2):
  - To set up the machine head (2) straight:  
Tighten the hinges (1) at the topmost position.
  - To set up the machine head (2) slanted:  
Tighten the hinges (1) at the bottommost position.



**Important**

If the machine head is supposed to be set up in a slanted position, insert the plastic shims into the tabletop cutout (📖 p. 114).

*Fig. 83: Inserting the machine head (2)*

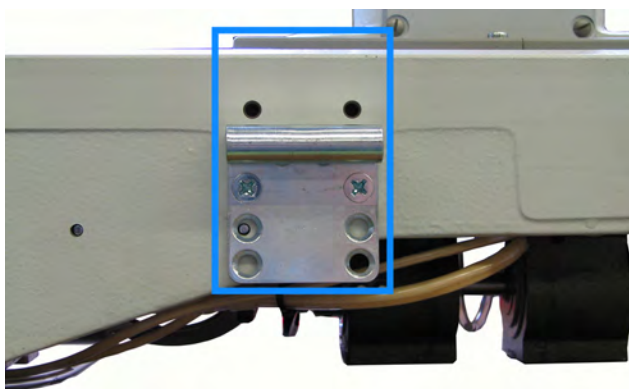

2. Guide the cables through the tabletop with great care so as not to kink or pinch them.
3. Insert the machine head (2) vertically into the tabletop cutout.

Fig. 84: Inserting the machine head (4)

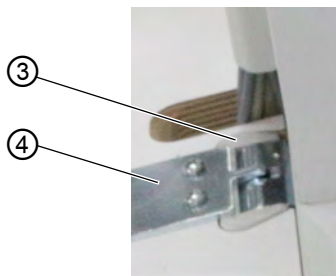

(3) - Lower hinge part

(4) - Tilt protection device



4. Insert the hinges (1) into the lower hinge parts (3).
5. Use the tilt protection device (4) to secure the machine head at the right hinge (1).

Fig. 85: Inserting the machine head (5)

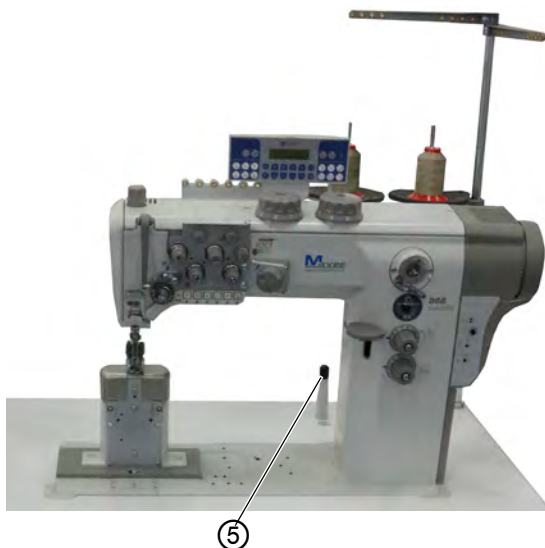

(5) - Tilt protection device

The machine head is secured further with the tilt protection device (5).

## 7.8 Setting the working height

### WARNING



#### Risk of crushing!

The tabletop can sink under its own weight when the screws on the stand bars are loosened.

Ensure that your hands are not jammed when loosening the screws.

### CAUTION



#### Risk of musculoskeletal damage from incorrect setting!

The operator can sustain musculoskeletal damage if failing to comply with the ergonomic requirements.

Adjust the working height to the body height of the person who will operate the machine.

Fig. 86: Assembling the stand

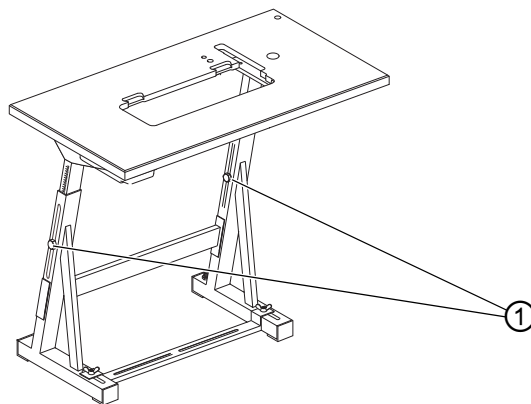

(1) - Screw

The working height ranges between 750-900 mm, measured from the top edge of the tabletop.



To set the working height:

1. Loosen both screws (1).
2. Set the tabletop to the desired working height.

Make sure the tabletop remains horizontal and does not tilt.

3. Tighten both screws (1).

## 7.9 Setting the pedal

Fig. 87: Setting the pedal

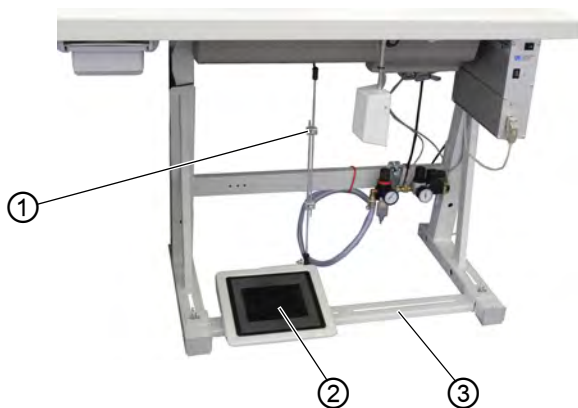

(1) - Screw  
(2) - Pedal

(3) - Cross strut

The pedal (2) must be tilted to a degree that allows the user to move the pedal forward and backward without a problem.



To set the pedal properly:

1. Loosen the screw (1).
2. Set the pedal (2) to the proper position on the cross strut (3) ( p. 117).
3. Tighten the screw (1).

## 7.10 Assembling the control panel

All CLASSIC machines are equipped with the OP1000 control panel.

Fig. 88: Assembling the control panel

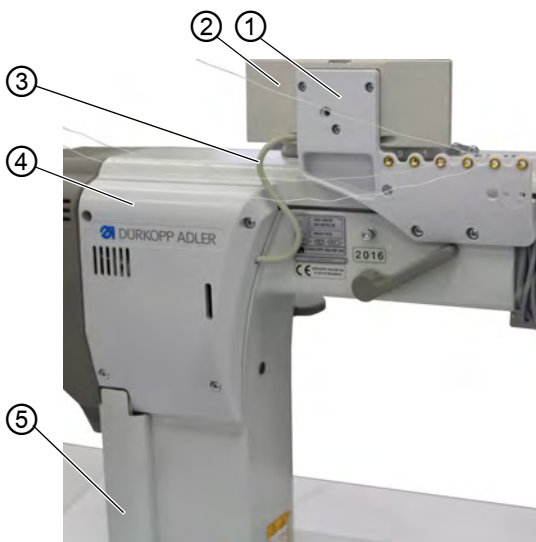

- |                        |                          |
|------------------------|--------------------------|
| (1) - Mounting bracket | (4) - Cover              |
| (2) - Control panel    | (5) - Cover (cable duct) |
| (3) - Connecting cable |                          |



To assemble the control panel:

1. Tighten the mounting bracket (1) on the machine head.
2. Remove the cover (4).
3. Remove the cover from the cable duct (5).
4. Tighten the control panel (2) on the mounting bracket (1).
5. Guide the connecting cable (3) behind covers (4) and (5) and down through the tabletop cutout towards the control.
6. Assemble cover (4) and cover (5).

Make sure not to damage the connecting cable (3) or the other cables.

## 7.11 Assembling the knee lever / knee button

The machine has either a mechanical or electrical knee lever, depending on subclass and equipment.

### 7.11.1 Assembling the mechanical knee lever

Fig. 89: Assembling the mechanical knee lever (1)

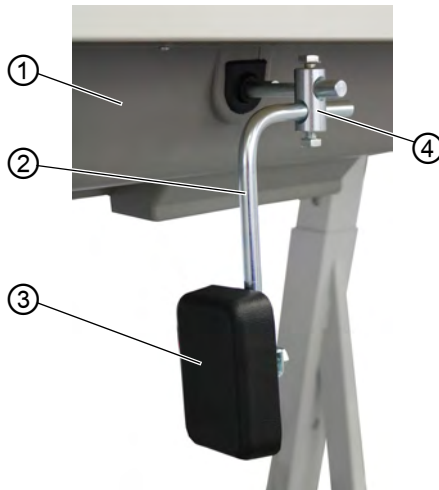

(1) - Oil pan  
(2) - Rod

(3) - Knee lever  
(4) - Connecting piece

Fig. 90: Assembling the mechanical knee lever (2)

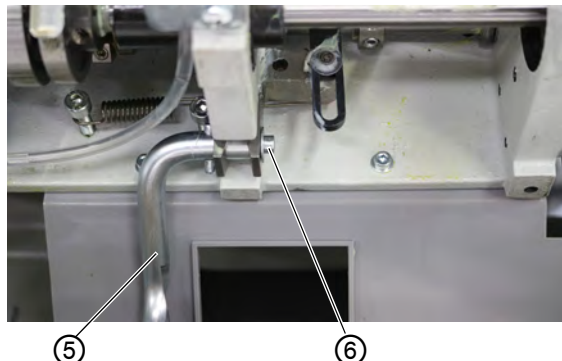

(5) - Transmission rod

(6) - Screw



To assemble the mechanical knee lever:

1. Tilt the machine head.
  2. Guide the transmission rod (5) through the oil pan (1).
  3. Assemble the transmission rod (5) on the machine head using the screw (6).
  4. Screw the rod (2) and the knee lever (3) together.
  5. Assemble the rod (2) to the transmission rod (5) using the connecting piece (4).
  6. Erect the machine head.
- ↳ The knee lever (3) automatically moves to its initial position and is ready for operation.

### 7.11.2 Assembling the electric knee button

Fig. 91: Assembling the electric knee button

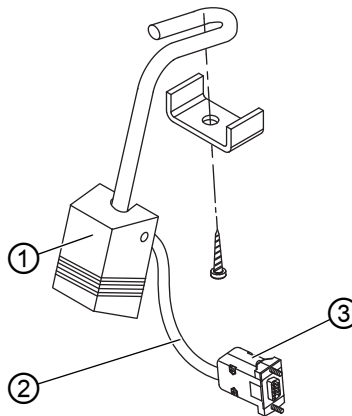

- (1) - Knee button  
(2) - Connecting cable

(3) - Plug



To assemble the electric knee button:

1. Screw the knee button (1) in front of the oil pan firmly in place under the tabletop.
2. Guide the connecting cable (2) to the back between the oil pan and the control.
3. Insert the plug (3) of the connecting cable (2) into the socket of the control.



## 7.12 Assembling the oil extraction line

Fig. 92: Assembling the oil extraction line (1)

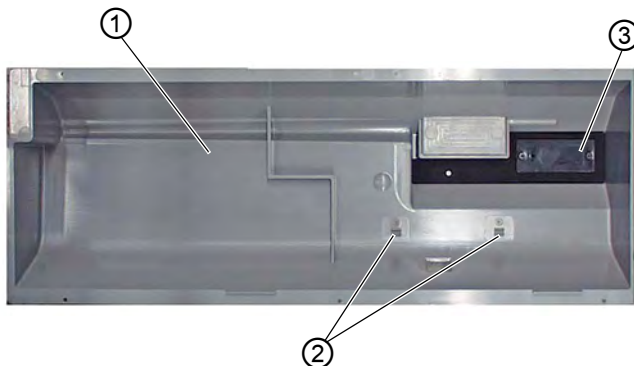

(1) - Oil pan

(2) - Tube holder

(3) - Cover

Fig. 93: Assembling the oil extraction line (2)

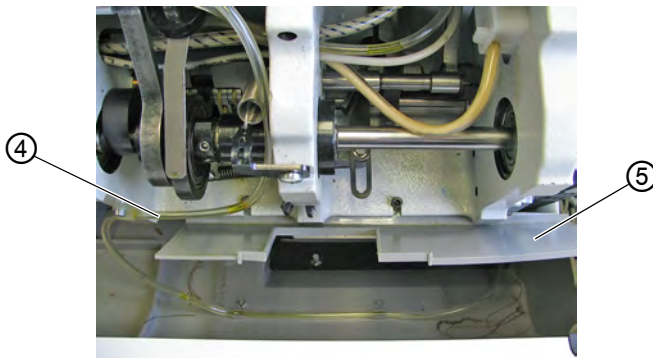

(4) - Oil extraction line

(5) - Cover



To assemble the oil extraction line:

1. Tilt the machine head.
2. Remove the plug at the end of the oil extraction line (4).
3. Slip the end of the oil extraction line onto the adapter on the cover (3).
4. Clip the oil extraction line (4) into the tube holder (2).
5. Screw the cover (5) to the base plate.

## 7.13 Electrical connection

### DANGER



#### Risk of death from live components!

Unprotected contact with electricity can result in serious injuries or death.

Only qualified specialists may perform work on electrical equipment.



#### Important

The voltage on the type plate of the sewing motor must correspond to the mains voltage.

## 7.14 Establishing equipotential bonding

### NOTICE

#### Property damage may occur!

Crushing and cable breakage possible.

When laying the grounding wire, ensure that the wire is not pinched.

Fig. 94: Establishing equipotential bonding

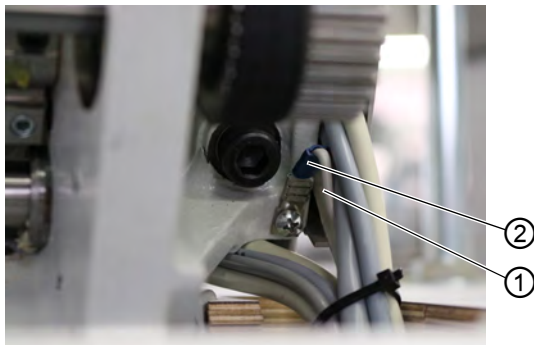

(1) - Grounding wire

(2) - Tab connector

The grounding wire conducts away any static charging of the machine head.

The grounding wire is included in the accessory pack for the machine.



To establish equipotential bonding:

1. Plug in the grounding wire (1) with the tab connector (2) at the designated position on the right of the machine head.
2. Tighten the grounding wire (1) to the control at the designated position (top right).

## 7.15 Pneumatic connection

### NOTICE

#### **Property damage from oily compressed air!**

Oil particles in the compressed air can cause malfunctions of the machine and soil the sewing material.

Ensure that no oil particles enter the compressed air supply.

### NOTICE

#### **Property damage from incorrect setting!**

Incorrect system pressure can result in damage to the machine.

Ensure that the machine is only used when the system pressure is set correctly.

The pneumatic system of the machine and of the additional equipment must be supplied with dry and oil-free compressed air. The supply pressure must lie between 8 and 10 bar.

### 7.15.1 Assembling the compressed air maintenance unit



To assemble the compressed air maintenance unit:

1. Connect the connection hose ( $\varnothing = 9$  mm) to the compressed air supply using a hose coupling R 1/4".

### 7.15.2 Setting the operating pressure

#### NOTICE

#### Property damage from incorrect setting!

Incorrect operating pressure can result in damage to the machine.

Ensure that the machine is only used when the operating pressure is set correctly.



#### Proper setting

Refer to the **Technical data** (📖 p. 149) chapter for the permissible operating pressure. The operating pressure cannot deviate by more than  $\pm 0.5$  bar.

Fig. 95: Setting the operating pressure

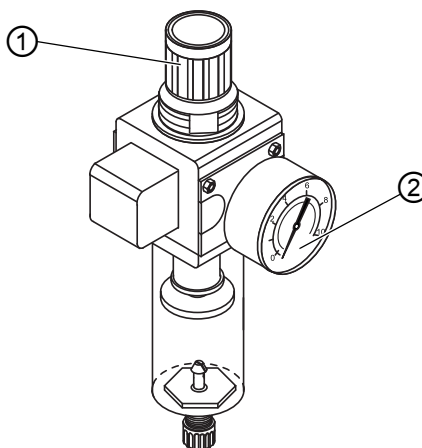

(1) - Pressure controller

(2) - Pressure gauge



To set the operating pressure:

1. Pull the pressure controller (1) up.
2. Turn the pressure controller until the pressure gage (2) indicates the proper setting:
  - Increase pressure = turn clockwise
  - Reduce pressure = turn counterclockwise
3. Push the pressure controller (1) down.

## 7.16 Checking the lubrication

All wicks and felt bits of the machine head are soaked in oil at the factory. This oil is conveyed to the reservoir during use. This is why you should avoid filling too much oil during initial filling.

Fig. 96: Checking the lubrication

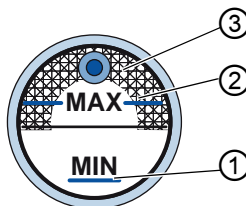

(1) - Minimum level marking  
(2) - Maximum level marking

(3) - Inspection glass



To check the lubrication:

1. Sew with the machine for approx. 1 minute.
2. Check at the inspection glass (3) whether the warning indicator is lit red or the oil level has dropped below the minimum marking (1).
3. If this is the case, top off oil ( p. 101).

## 7.17 Performing a test run

When setup is complete, perform a test run to check the functionality of the machine.



## 8 Decommissioning

### WARNING



#### **Risk of injury from a lack of care!**

Serious injuries may occur.

ONLY clean the machine when it is switched off.  
Allow ONLY trained personnel to disconnect the machine.

### CAUTION



#### **Risk of injury from contact with oil!**

Oil can cause a rash if it comes into contact with skin.

Avoid skin contact with oil.

If oil has come into contact with your skin, wash the affected areas thoroughly.



To decommission the machine:

1. Switch off the machine.
2. Unplug the power plug.
3. If applicable, disconnect the machine from the compressed air supply.
4. Remove residual oil from the oil pan using a cloth.
5. Cover the control panel to protect it from soiling.
6. Cover the control to protect it from soiling.
7. Cover the entire machine if possible to protect it from contamination and damage.





## 9 Disposal

### CAUTION



#### **Risk of environmental damage from improper disposal!**

Improper disposal of the machine can result in serious environmental damage.

ALWAYS comply with the national regulations regarding disposal.

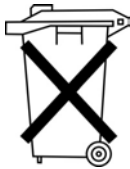

The machine must not be disposed of in the normal household waste.

The machine must be disposed of in a suitable manner in accordance with all applicable national regulations.

When disposing of the machine, be aware that it consists of a range of different materials (steel, plastic, electronic components, etc.). Follow the national regulations when disposing these materials.



---

## 10 Troubleshooting

### 10.1 Customer Service

Contact for repairs and issues with the machine:

#### **Dürkopp Adler AG**

Potsdamer Str. 190  
33719 Bielefeld, Germany

Tel. +49 (0) 180 5 383 756

Fax +49 (0) 521 925 2594

Email: [service@duerkopp-adler.com](mailto:service@duerkopp-adler.com)

Internet: [www.duerkopp-adler.com](http://www.duerkopp-adler.com)



### 10.2 Messages of the software

Please contact customer service if an error occurs that is not described here. Do not attempt to correct the error yourself.

## 10.2.1 Information messages

Information	Possible cause	Remedial action
1203	Position not reached (during thread cutting, reversal, etc.)	<ul style="list-style-type: none"> <li>• Check the controller settings and change them if required; make mechanical changes to the machine (e.g. thread cutter, setting for belt tension, etc.)</li> <li>• Check position (thread lever at top dead center)</li> </ul>
2020	DACextension box not responding	<ul style="list-style-type: none"> <li>• Check connection cables</li> <li>• Check LEDs of DACextension box</li> <li>• Software update</li> </ul>
2021	Sewing motor encoder plug (Sub-D, 9-pin) not connected to DACextension box	<ul style="list-style-type: none"> <li>• Connect encoder cable to DACextension box using the correct connection</li> </ul>
2120	DA stepper card 1 not responding	<ul style="list-style-type: none"> <li>• Check connection cables</li> <li>• Check LEDs of DACextension box</li> <li>• Software update</li> </ul>
2121	DA stepper card 1 encoder plug (Sub-D, 9-pin) not connected	<ul style="list-style-type: none"> <li>• Connect encoder cable to the control, use correct connection</li> </ul>
2122	DA stepper card 1 flywheel position not found	<ul style="list-style-type: none"> <li>• Check connection cables</li> <li>• Check stepper motor 1 for stiff movement</li> </ul>
2220	DA stepper card 2 not responding	<ul style="list-style-type: none"> <li>• Check connection cables</li> <li>• Check LEDs of DACextension box</li> <li>• Software update</li> </ul>

Information	Possible cause	Remedial action
2221	DA stepper card 2 encoder plug (Sub-D, 9-pin) not connected	<ul style="list-style-type: none"> <li>• Connect encoder cable to the control, use correct output</li> </ul>
2222	DA stepper card 2 flywheel position not found	<ul style="list-style-type: none"> <li>• Check connection cables</li> <li>• Check stepper motor 2 for stiff movement</li> </ul>
3103	Low voltage warning (1 <sup>st</sup> threshold) Mains voltage < 180 V AC	<ul style="list-style-type: none"> <li>• Check the mains voltage</li> <li>• Stabilize the mains voltage</li> <li>• Use generator</li> </ul>
3108	Speed limited due to insufficient mains voltage	<ul style="list-style-type: none"> <li>• Check the mains voltage</li> </ul>
3150	Maintenance necessary	<ul style="list-style-type: none"> <li>• Information on lubricating the machine  <i>Service Instructions</i></li> </ul>
3155	No release for sewing process	<ul style="list-style-type: none"> <li>• Parameter <b>t 51 20-t 51 33</b> = 25</li> <li>• Input signal for sewing process release required</li> </ul>
3160	Stitch loosening device	<ul style="list-style-type: none"> <li>• Stitch loosening cannot be performed</li> </ul>
3215	Bobbin stitch counter (info value <b>0</b> reached)	<ul style="list-style-type: none"> <li>• Change bobbin, set counter value</li> <li>• Press counter reset button</li> </ul>
3216	Remaining thread monitor left	<ul style="list-style-type: none"> <li>• Change the left bobbin</li> </ul>
3217	Remaining thread monitor right	<ul style="list-style-type: none"> <li>• Change the right bobbin</li> </ul>
3218	Remaining thread monitor left and right	<ul style="list-style-type: none"> <li>• Change the left and right bobbin</li> </ul>
3223	Skip stitch detected	
3224	Bobbin failed to rotate	

<b>Information</b>	<b>Possible cause</b>	<b>Remedial action</b>
6360	No valid data on external EEPROM (internal data structures are not compatible with the external data storage device)	<ul style="list-style-type: none"> <li>• Software update</li> </ul>
6361	No external EEPROM connected	<ul style="list-style-type: none"> <li>• Connect machine ID</li> </ul>
6362	No valid data on internal EEPROM (internal data structures are not compatible with the external data storage device)	<ul style="list-style-type: none"> <li>• Check machine ID connection</li> <li>• Switch off the control, wait until the LEDs are off, and then switch the control on again</li> <li>• Software update</li> </ul>
6363	No valid data on internal and external EEPROM (software version is not compatible with the internal data storage device, emergency operating features only)	<ul style="list-style-type: none"> <li>• Check machine ID connection</li> <li>• Switch off the control, wait until the LEDs are off, and then switch the control on again</li> <li>• Software update</li> </ul>
6364	No valid data on internal EEPROM and no external EEPROM connected (the internal data structures are not compatible with the external data storage device, emergency operating features only)	<ul style="list-style-type: none"> <li>• Check machine ID connection</li> <li>• Switch off the control, wait until the LEDs are off, and then switch the control on again</li> <li>• Software update</li> </ul>
6365	Internal EEPROM defective	<ul style="list-style-type: none"> <li>• Replace the control</li> </ul>
6366	Internal EEPROM defective and external data not valid (emergency operating features only)	<ul style="list-style-type: none"> <li>• Replace the control</li> </ul>
6367	Internal EEPROM defective and external EEPROM not connected (emergency operating features only)	<ul style="list-style-type: none"> <li>• Replace the control</li> </ul>

Information	Possible cause	Remedial action
7202	DACextension box boot error	<ul style="list-style-type: none"> <li>• Check connection cables</li> <li>• Software update</li> <li>• Replace DACextension box</li> </ul>
7203	Checksum error during update	<ul style="list-style-type: none"> <li>• Check connection cables</li> <li>• Software update</li> <li>• Replace DACextension box</li> </ul>
7212	DA stepper card 1 boot error	<ul style="list-style-type: none"> <li>• Check connection cables</li> <li>• Software update</li> <li>• Replace DACextension box</li> </ul>
7213	Checksum error occurred while updating DA stepper card 2	<ul style="list-style-type: none"> <li>• Check connection cables</li> <li>• Software update</li> <li>• Replace DACextension box</li> </ul>
7222	DA stepper card 2 boot error	<ul style="list-style-type: none"> <li>• Check connection cables</li> <li>• Software update</li> <li>• Replace DACextension box</li> </ul>
7223	Checksum error occurred while updating DA stepper card 2	<ul style="list-style-type: none"> <li>• Check connection cables</li> <li>• Software update</li> <li>• Replace DACextension box</li> </ul>
7801	Software version error (DAC classic only; only the functions of the DAC basic will remain available)	<ul style="list-style-type: none"> <li>• Software update</li> <li>• Replace the control</li> </ul>
7802	Software update error (DAC classic only; only the functions of the DAC basic will remain available)	<ul style="list-style-type: none"> <li>• Software update</li> <li>• Replace the control</li> </ul>
7803	Communication error (DAC classic only; only the functions of the DAC basic will remain available)	<ul style="list-style-type: none"> <li>• Restart of the control</li> <li>• Software update</li> <li>• Replace the control</li> </ul>

## 10.2.2 Error messages

Code	Error/warning	Possible cause	Remedial action
1000	Error	Sewing motor encoder plug (Sub-D, 9-pin) not connected	<ul style="list-style-type: none"> <li>• Connect encoder cable to the control, use correct connection</li> </ul>
1001	Error	Sewing motor error: Sewing motor plug (AMP) not connected	<ul style="list-style-type: none"> <li>• Check connection and plug in, if necessary</li> <li>• Test sewing motor phases (R= 2.8 Ω, high impedance to PE)</li> <li>• Replace the encoder</li> <li>• Replace sewing motor</li> <li>• Replace the control</li> </ul>
1002	Error	Sewing motor insulation fault	<ul style="list-style-type: none"> <li>• Check sewing motor phase and PE for low-impedance connection</li> <li>• Replace the encoder</li> <li>• Replace sewing motor</li> </ul>
1004	Error	Sewing motor error: Incorrect sewing motor direction of rotation	<ul style="list-style-type: none"> <li>• Replace the encoder</li> <li>• Check plug assignment and change, if necessary</li> <li>• Check wiring in machine distributor and change it, if necessary</li> <li>• Test sewing motor phases and check for correct value</li> </ul>
1005	Error	Sewing motor blocked	<ul style="list-style-type: none"> <li>• Eliminate stiff movement in the sewing machine</li> <li>• Replace the encoder</li> <li>• Replace sewing motor</li> </ul>
1006	Error	Maximum speed exceeded	<ul style="list-style-type: none"> <li>• Replace the encoder</li> <li>• Perform reset</li> <li>• Check class (<b>t 51 04</b>)</li> </ul>
1007	Error	Error in the reference run	<ul style="list-style-type: none"> <li>• Replace the encoder</li> <li>• Eliminate stiff movement in the sewing machine</li> </ul>





















Code	Error/warning	Possible cause	Remedial action
1008	Error	Encoder error	<ul style="list-style-type: none"> <li>• Replace the encoder</li> </ul>
1010	Error	External synchronizer plug (Sub-D, 9-pin) not connected	<ul style="list-style-type: none"> <li>• Connect cable of external synchronizer to control; use correct connection (Sync)</li> <li>• Only required for machines with transmission!</li> </ul>
1011	Error	Encoder Z pulse missing	<ul style="list-style-type: none"> <li>• Switch off the control, adjust the handwheel, and switch the control on again</li> <li>• If error is not corrected, check encoder</li> </ul>
1012	Error	Synchronizer fault	<ul style="list-style-type: none"> <li>• Replace the synchronizer</li> </ul>
1052	Error	Sewing motor overcurrent, internal current increase >25 A	<ul style="list-style-type: none"> <li>• Check selection of class</li> <li>• Replace the control</li> <li>• Replace sewing motor</li> <li>• Replace the encoder</li> </ul>
1053	Error	Sewing motor overvoltage	<ul style="list-style-type: none"> <li>• Check selection of class</li> <li>• Replace the control</li> </ul>
1054	Error	Internal short circuit	<ul style="list-style-type: none"> <li>• Replace the control</li> </ul>
1055	Error	Sewing motor overload	<ul style="list-style-type: none"> <li>• Eliminate stiff movement in the sewing machine</li> <li>• Replace the encoder</li> <li>• Replace sewing motor</li> </ul>
2101	Error	DA stepper card 1 reference run timeout	<ul style="list-style-type: none"> <li>• Check reference sensor</li> </ul>
2103	Error	DA stepper card 1 step losses	<ul style="list-style-type: none"> <li>• Check for stiff movement</li> </ul>
2155	Error	DA stepper card 1 overload	<ul style="list-style-type: none"> <li>• Check for stiff movement</li> </ul>

<b>Code</b>	<b>Error/ warning</b>	<b>Possible cause</b>	<b>Remedial action</b>
2201	Error	DA stepper card 2 reference run timeout	<ul style="list-style-type: none"> <li>• Check reference sensor</li> </ul>
2203	Error	DA stepper card 2 step losses	<ul style="list-style-type: none"> <li>• Check for stiff movement</li> </ul>
2255	Error	DA stepper card 2 overload	<ul style="list-style-type: none"> <li>• Check for stiff movement</li> </ul>
3100	Error	AC-RDY timeout, intermediate circuit voltage did not reach the defined threshold in the specified time	<ul style="list-style-type: none"> <li>• Check the mains voltage</li> <li>• If the mains voltage is OK, replace the control</li> </ul>
3101	Error	High voltage fault, mains voltage > 290 V for an extended period	<ul style="list-style-type: none"> <li>• Check mains voltage, if nominal voltage is continuously exceeded</li> <li>• stabilize it or use a generator</li> </ul>
3102	Error	Low voltage failure (2nd threshold), mains voltage < 150 V AC	<ul style="list-style-type: none"> <li>• Check the mains voltage</li> <li>• Stabilize the mains voltage</li> <li>• Use generator</li> </ul>
3104	Warning	Pedal is not in position 0	<ul style="list-style-type: none"> <li>• When switching the control on, take your foot off the pedal</li> </ul>
3105	Error	U24 V short circuit	<ul style="list-style-type: none"> <li>• Disconnect 37-pin plug</li> <li>• Replace control if error is not corrected</li> <li>• Test inputs/outputs for 24 V short circuit</li> </ul>
3106	Error	U24 V ( $I^2T$ ) overload	<ul style="list-style-type: none"> <li>• One or several magnets defective</li> </ul>
3107	Error	Pedal not connected	<ul style="list-style-type: none"> <li>• Connect analog pedal</li> </ul>
3109	Warning	Operation lock	<ul style="list-style-type: none"> <li>• Check tilt sensor on machine</li> </ul>

Code	Error/warning	Possible cause	Remedial action
3151	Warning	Maintenance necessary (operation cannot continue unless parameter <b>t 51 14</b> is reset)	<ul style="list-style-type: none"> <li>• Service is urgently required  <i>Service Instructions</i></li> </ul>
6353	Error	Internal EEPROM communication error	<ul style="list-style-type: none"> <li>• Switch off the control</li> <li>• Wait until the LEDs are off</li> <li>• Switch the machine back on</li> </ul>
6354	Error	External EEPROM communication error	<ul style="list-style-type: none"> <li>• Switch off the control</li> <li>• Wait until the LEDs are off</li> <li>• Check machine ID connection</li> <li>• Switch the control back on</li> </ul>
8401	Error	Watchdog	<ul style="list-style-type: none"> <li>• Software update</li> <li>• Machine ID reset</li> <li>• Replace the control</li> </ul>
8402-8405	Error	Internal error	<ul style="list-style-type: none"> <li>• Software update</li> <li>• Machine ID reset</li> <li>• Replace the control</li> </ul>
8406	Error	Checksum error	<ul style="list-style-type: none"> <li>• Software update</li> <li>• Replace the control</li> </ul>
8501	Error	Software protection	<ul style="list-style-type: none"> <li>• Always use the DA tool for software updates</li> </ul>

### 10.3 Errors in sewing process

<b>Error</b>	<b>Possible causes</b>	<b>Remedial action</b>
Unthreading at seam beginning	Needle thread tension is too firm	Check needle thread tension  p. 47
Thread breaking	Needle thread and hook thread have not been threaded correctly	Check threading path  p. 28
	Needle is bent or sharp-edged	Replace the needle  p. 24
	Needle is not inserted correctly into the needle bar	Insert the needle correctly into the needle bar  p. 24
	The thread used is unsuitable	Use recommended thread  p. 149
	Thread tensions are too tight for the thread used	Check thread tensions  p. 47
	Thread-guiding parts, such as thread tube, thread guide or thread take-up disk, are sharp-edged	Check threading path  p. 28
	Throat plate, hook or spread have been damaged by the needle	Have parts reworked by qualified specialists  p. 137
Missing stitches	Needle thread and hook thread have not been threaded correctly	Check threading path  p. 28
	Needle is blunt or bent	Replace the needle  p. 24
	Needle is not inserted correctly into the needle bar	Insert the needle correctly into the needle bar  p. 24
	The needle thickness used is unsuitable	Use recommended needle thickness  p. 149
	The reel stand is assembled incorrectly	Check the assembly of the reel stand  p. 119
	Thread tensions are too tight	Check thread tensions  p. 47
	Throat plate, hook or spread have been damaged by the needle	Have parts reworked by qualified specialists  p. 137

Error	Possible causes	Remedial action
Loose stitches	Thread tensions are not adjusted to the sewing material, the sewing material thickness or the thread used	Check thread tensions  p. 47
	Needle thread and hook thread have not been threaded correctly	Check threading path  p. 28
Needle breakage	Needle thickness is unsuitable for the sewing material or the thread	Use recommended needle thickness  p. 149



# 11 Technical data

## 11.1 Data and characteristic values

Technical data	Subclass							
	-190020-M ECO	-190322-M	-290020-M ECO	-290322-M	-290341-M	-290321-M	-390322-M	-490322-M
Machine type	Special sewing machine							
Type of stitches	Double lockstitch machine 301							
Vertical hook with size	L			XXL	L			
Number of needles	1	2				1	2	
Switchable needle bars		-					x	
Needle system	134-35							
Maximum needle strength [Nm] • for light to moderately heavy sewing material • for moderately heavy sewing material • for heavy sewing material	90-110 110-140 140-180							
Thread strength [Nm]	80/3-10/3							
Stitch length forwards/backwards [mm]	12/12							
Number of adjustable stitch lengths	2	1	2					
Maximum speed [min <sup>-1</sup> ]	2500							
Speed on delivery [min <sup>-1</sup> ]	2500							
Maximum stroke height (only with reversing mechanism) [mm]	20							

Technical data	Subclass							
	-190020-M ECO	-190322-M	-290020-M ECO	-290322-M	-290341-M	-290321-M	-390322-M	-490322-M
Maximum sewing foot stroke	9							
Operating pressure [bar]		6						6
Air consumption [NL]		0.7						0.7
Length [mm]	690							
Width [mm]	220							
Height [mm]	480							
Weight with direct drive [kg]	72			74			72	74
Rated voltage [V, Hz]	230, 50/60							
Rated voltage on delivery [V, Hz]	230, 50/60							
Rated power [W]	375							

## 11.2 Permissible maximum speeds

To ensure safe operation, optimum sewing results and a long service life of the machine, do NOT exceed the permissible maximum speeds:

Subclass	Stitch length range [mm]	Sewing foot stroke Adjusting wheel position	Maximum speed [min <sup>-1</sup> ]
868-190322-M	0-8	1-2, 5	2500
868-290322-M		3	2400
868-190020-M		4	2200
		5	2000
868-290020-M	8-12	6	1800
		7-9	1600
		1-9	1600



### 11.3 Characteristics

The characteristics of the machine vary with the subclass it belongs to:

- large (L)/extra-large (XXL) vertical hook
- DAC classic control
- Control panel OP 1000
- Integrated winder
- The clearance under the sewing feet when lifted is max. 20 mm (all subclasses, except those that do not include a thread cutter, require a drive with reversing mechanism to allow for the positioning of the needle above the sewing feet)
- The remaining thread length following the thread cutting process is approx. 15 mm
- A safety snap-on coupling prevents any misadjustment of the hook or damage to the hook in the event of a hook thread jamming
- Automatic wick lubrication with an inspection glass housed in the machine arm for lubricating the machine and the hook
- Except for the machines in the ECO subclass, all subclasses come with a push button panel including 6 buttons
- A fully customizable favorite button within easy reach of the user (possible functions are: Needle up/down, bartack suppression, second stitch length, switchable thread tension, and lower edge stop)
- The possible needle spacing for the vertical L hook with and without thread cutter is 3-63 mm
- The possible needle spacing for the vertical XXL hook with and without thread cutter is 3-56 mm
- Subclass 868-490322-M is equipped with switchable needle bars



# 12 Appendix

Fig. 97: Wiring diagram (1)

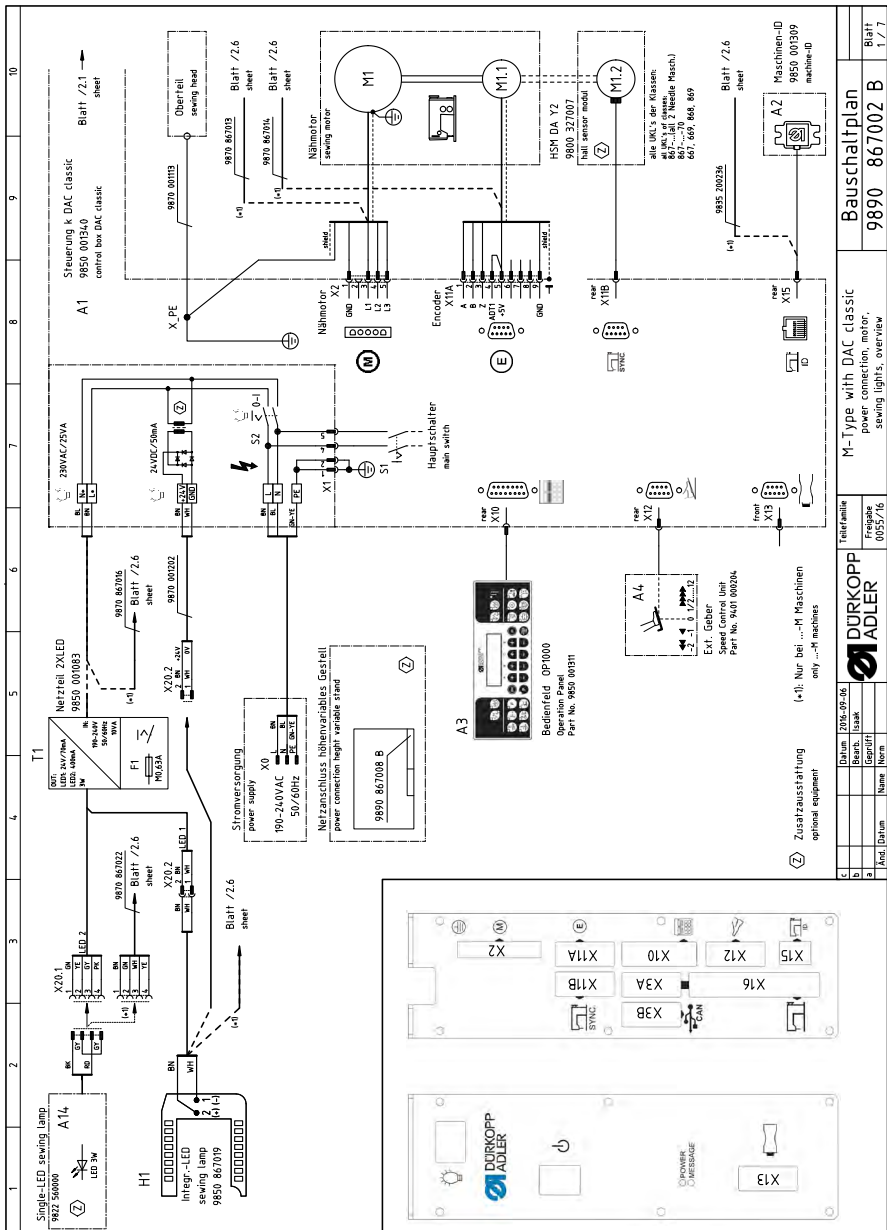
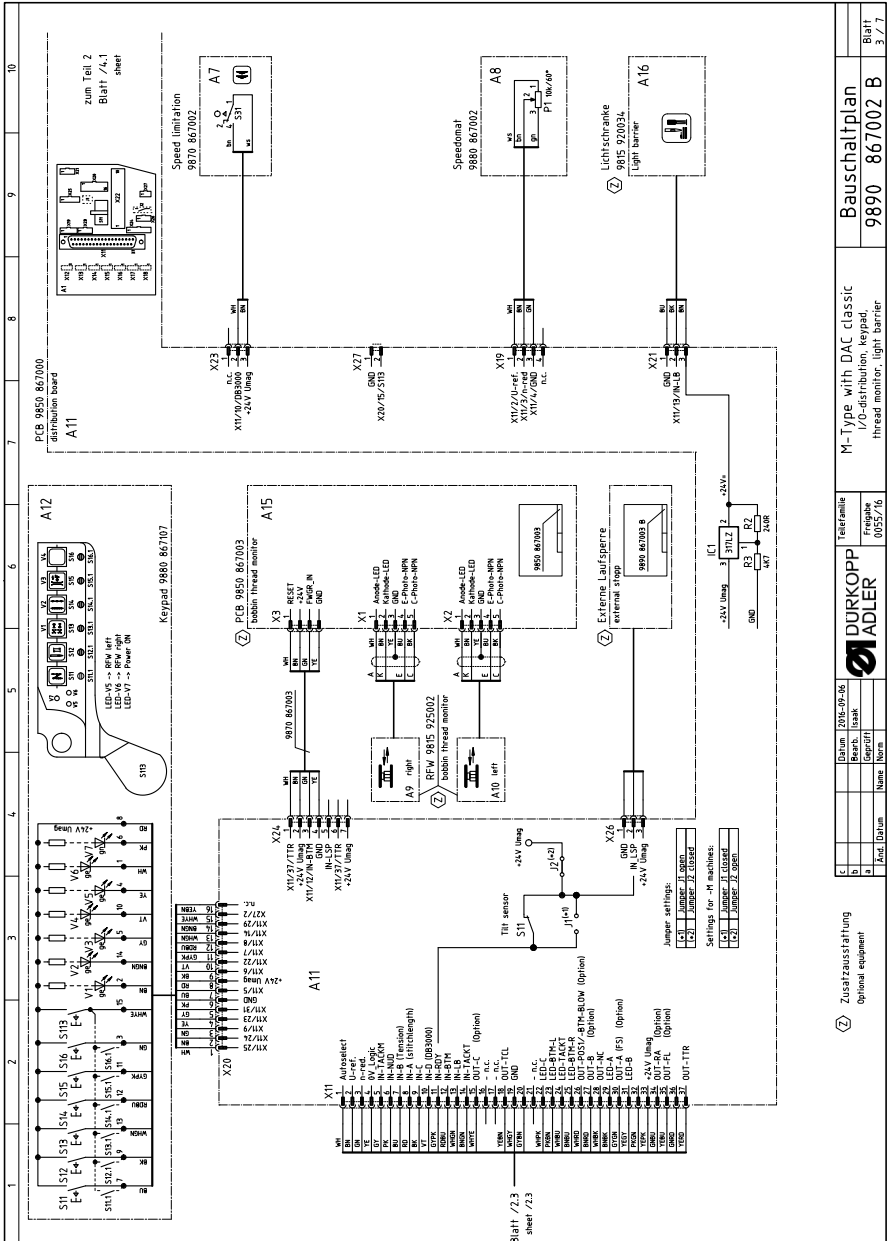

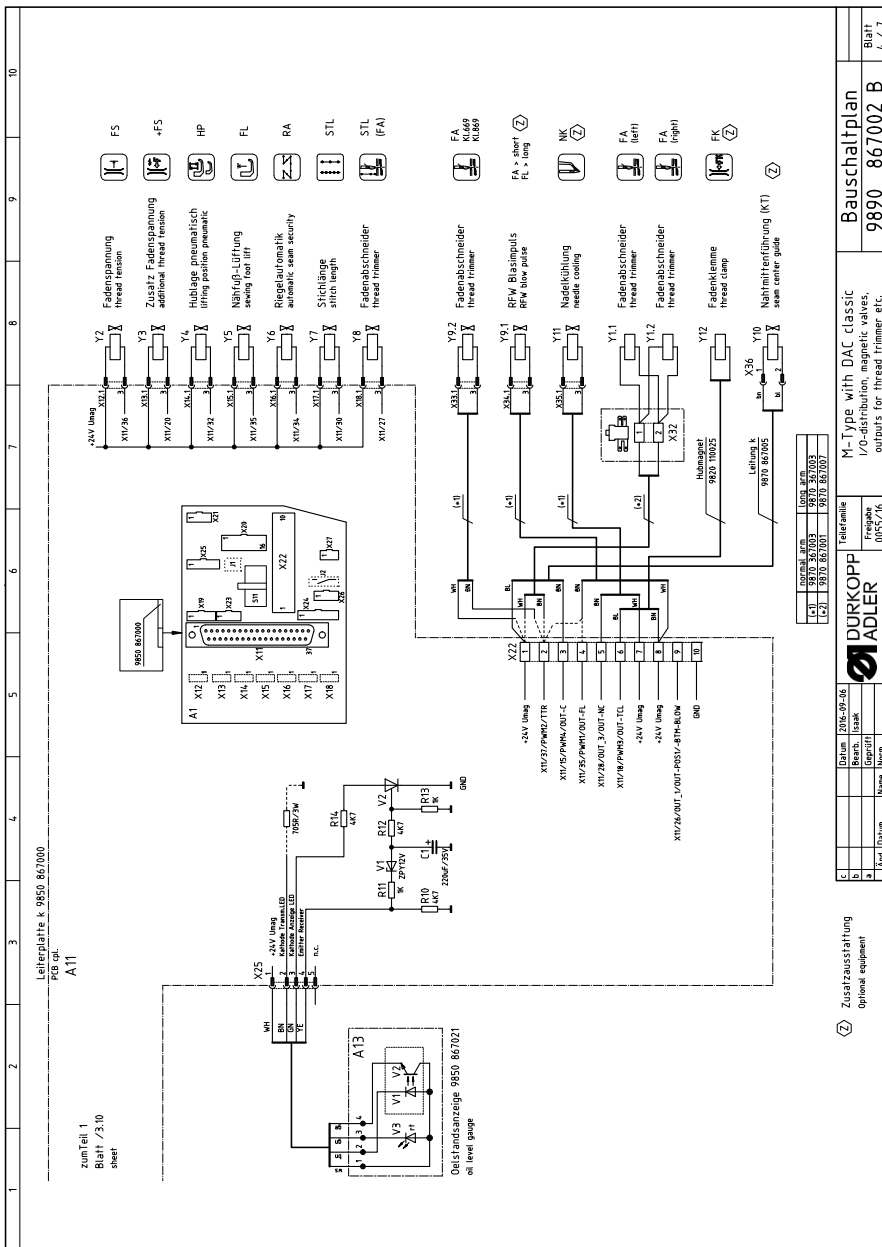

Fig. 99: Wiring diagram (3)



Zusatzanstattung optional equipment		DURKOPP ADLER		Teilnr./ Part no. 0055/16		M-Type with DAC classic 1/0-distribution, keypad, thread monitor, light barrier		Bauschaltplan 9890 867002 B		Blatt 3 / 7	
c		d		e		f		g		h	
1		2		3		4		5		6	
7		8		9		10		11		12	

Fig. 100: Wiring diagram (4)



Blatt 4 / 7																																																					
Bauschaltplan 9850 867002 B																																																					
M-Type with DAC classic I/O-distribution, magnetic valves, outputs for thread trimmer etc.																																																					
<table border="1"> <tr> <th colspan="2">Terminale</th> </tr> <tr> <td>1</td> <td>0055/B</td> </tr> <tr> <td>2</td> <td>0055/B</td> </tr> <tr> <td>3</td> <td>0055/B</td> </tr> <tr> <td>4</td> <td>0055/B</td> </tr> <tr> <td>5</td> <td>0055/B</td> </tr> <tr> <td>6</td> <td>0055/B</td> </tr> <tr> <td>7</td> <td>0055/B</td> </tr> <tr> <td>8</td> <td>0055/B</td> </tr> <tr> <td>9</td> <td>0055/B</td> </tr> <tr> <td>10</td> <td>0055/B</td> </tr> <tr> <td>11</td> <td>0055/B</td> </tr> <tr> <td>12</td> <td>0055/B</td> </tr> <tr> <td>13</td> <td>0055/B</td> </tr> <tr> <td>14</td> <td>0055/B</td> </tr> <tr> <td>15</td> <td>0055/B</td> </tr> <tr> <td>16</td> <td>0055/B</td> </tr> <tr> <td>17</td> <td>0055/B</td> </tr> <tr> <td>18</td> <td>0055/B</td> </tr> <tr> <td>19</td> <td>0055/B</td> </tr> <tr> <td>20</td> <td>0055/B</td> </tr> <tr> <td>21</td> <td>0055/B</td> </tr> <tr> <td>22</td> <td>0055/B</td> </tr> <tr> <td>23</td> <td>0055/B</td> </tr> <tr> <td>24</td> <td>0055/B</td> </tr> <tr> <td>25</td> <td>0055/B</td> </tr> </table>		Terminale		1	0055/B	2	0055/B	3	0055/B	4	0055/B	5	0055/B	6	0055/B	7	0055/B	8	0055/B	9	0055/B	10	0055/B	11	0055/B	12	0055/B	13	0055/B	14	0055/B	15	0055/B	16	0055/B	17	0055/B	18	0055/B	19	0055/B	20	0055/B	21	0055/B	22	0055/B	23	0055/B	24	0055/B	25	0055/B
Terminale																																																					
1	0055/B																																																				
2	0055/B																																																				
3	0055/B																																																				
4	0055/B																																																				
5	0055/B																																																				
6	0055/B																																																				
7	0055/B																																																				
8	0055/B																																																				
9	0055/B																																																				
10	0055/B																																																				
11	0055/B																																																				
12	0055/B																																																				
13	0055/B																																																				
14	0055/B																																																				
15	0055/B																																																				
16	0055/B																																																				
17	0055/B																																																				
18	0055/B																																																				
19	0055/B																																																				
20	0055/B																																																				
21	0055/B																																																				
22	0055/B																																																				
23	0055/B																																																				
24	0055/B																																																				
25	0055/B																																																				
<table border="1"> <tr> <th>Art</th> <th>Ursprung</th> <th>Name</th> <th>Item</th> </tr> <tr> <td>c</td> <td></td> <td>Datum</td> <td>2016-09-26</td> </tr> <tr> <td>b</td> <td></td> <td>Bezeichnung</td> <td>Bezeichnung</td> </tr> <tr> <td>a</td> <td></td> <td>Gezeichnet</td> <td>Gezeichnet</td> </tr> <tr> <td></td> <td></td> <td>Geprüft</td> <td>Geprüft</td> </tr> </table>		Art	Ursprung	Name	Item	c		Datum	2016-09-26	b		Bezeichnung	Bezeichnung	a		Gezeichnet	Gezeichnet			Geprüft	Geprüft																																
Art	Ursprung	Name	Item																																																		
c		Datum	2016-09-26																																																		
b		Bezeichnung	Bezeichnung																																																		
a		Gezeichnet	Gezeichnet																																																		
		Geprüft	Geprüft																																																		
Zusatzausstattung optionale equipment																																																					

Fig. 101: Wiring diagram (5)

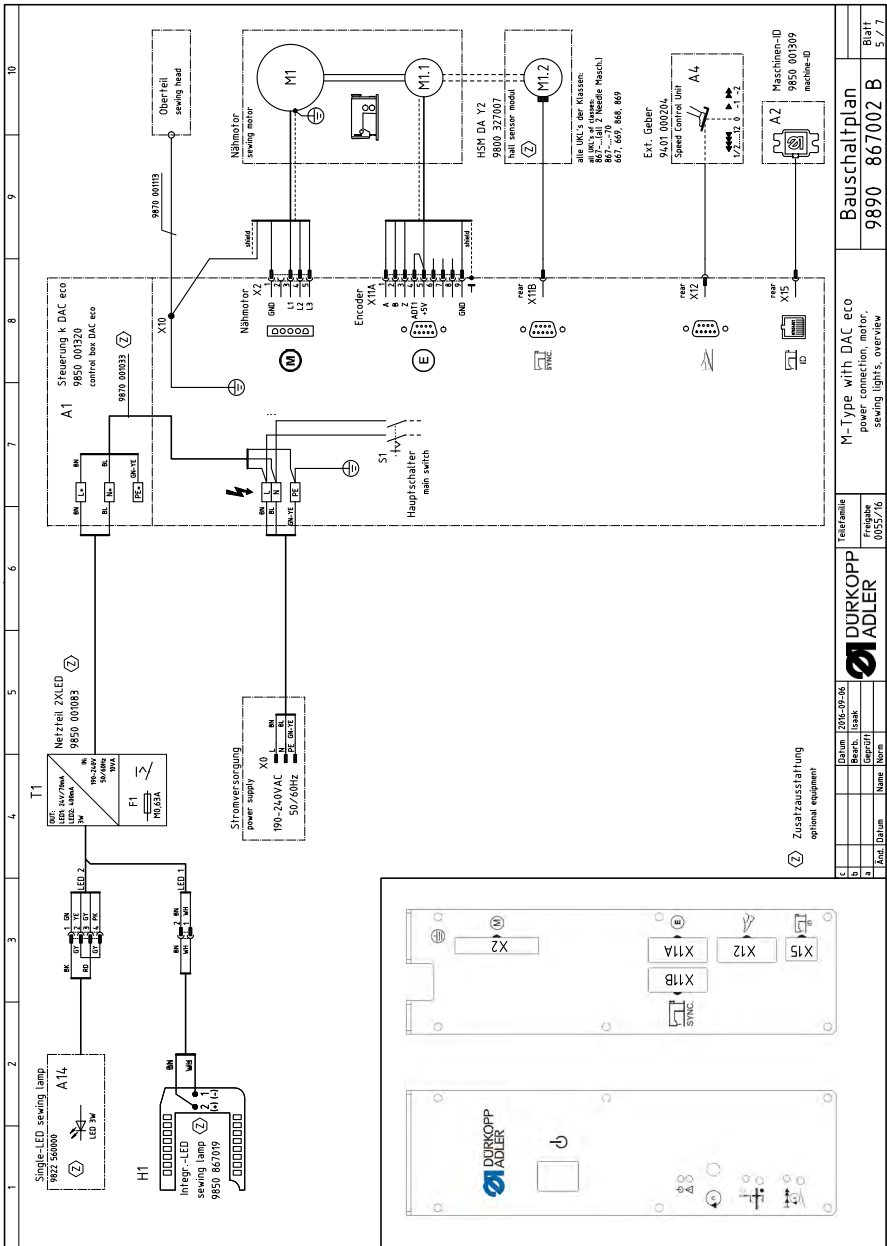

Date: 2016-09-06			Bauschaltplan		Blatt 5 / 7
a	Bezeichnung		M-Type with DAC eco		
b	Gezeichnet		power connection, motor, sewing lights, overview		
c	Geprüft		9890 867002 B		
d	Freigegeben	00557/16			
Zusatzausstattung optional equipment					

Fig. 102: Wiring diagram (6)

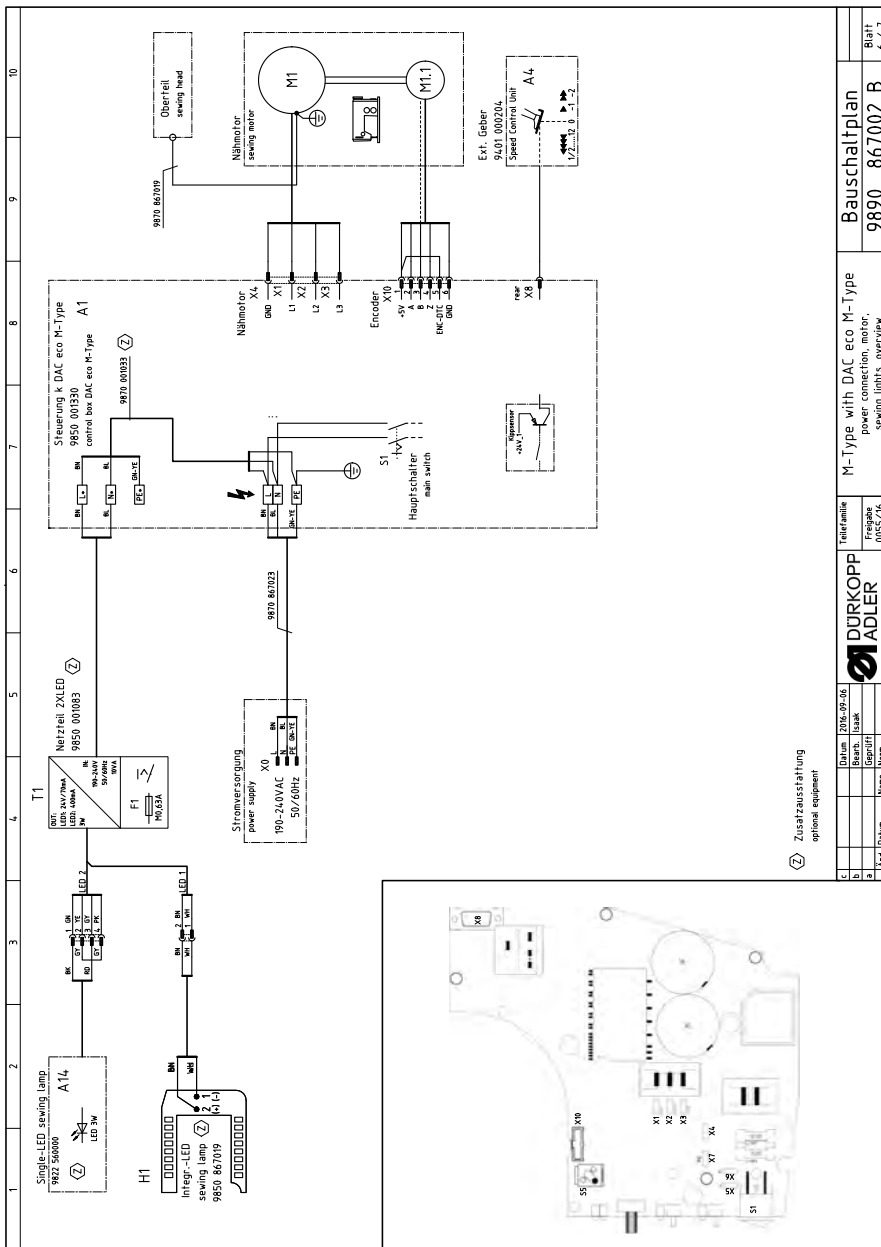

Blatt 6 / 7	
Bauschaltplan 9890 867002 B	
M-Type with DAC eco M-Type power connection, motor, sewing lights, overview	
Terminliste Freigebe 0055716	
<b>DURKOPP ADLER</b>	
Druck	2016-09-26
Beleg	1/2/3/4
Geprüft	
Name	
Druck	



Fig. 103: Wiring diagram (7)

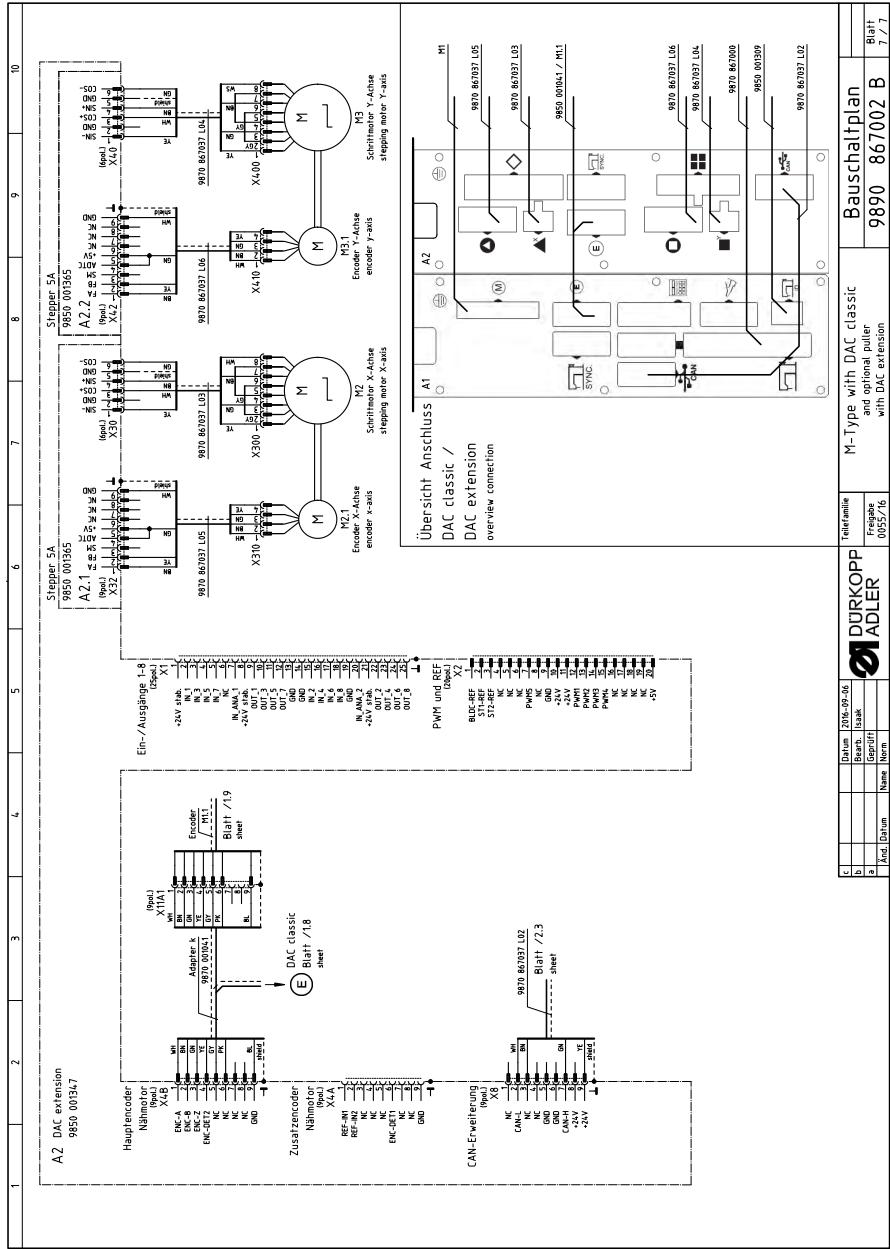

Datei		2016-09-26
Bearb.		Isak
Geprüft		
Name		Isak
Datum		

Titelzeile		M-Type with DAC classic and optional pulser with DAC extension
Freigabe		00557/16

DURKOPP ADLER	
Bauschaltplan	
9890 867002 B	
Blatt	
7 / 7	

Fig. 104: Tabletop drawing (1)

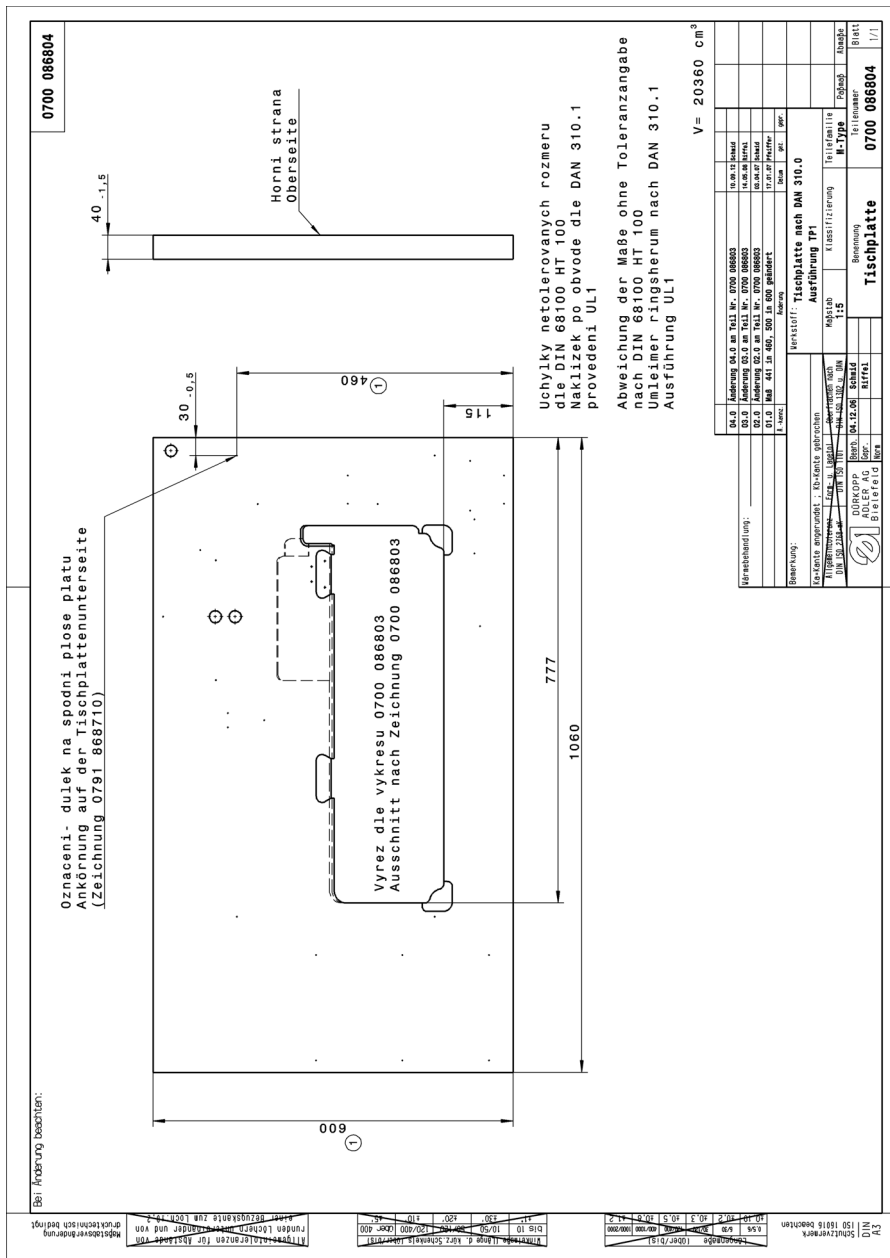













DÜRKOPP ADLER AG  
Potsdamer Str. 190  
33719 Bielefeld  
Germany  
Phone: +49 (0) 521 925 00  
Email: [service@duerkopp-adler.com](mailto:service@duerkopp-adler.com)  
[www.duerkopp-adler.com](http://www.duerkopp-adler.com)