

867-M PREMIUM Operating Instructions



IMPORTANT
READ CAREFULLY BEFORE USE
KEEP FOR FUTURE REFERENCE

All rights reserved.

Property of Dürkopp Adler AG and protected by copyright. Any reuse of these contents, including extracts, is prohibited without the prior written approval of Dürkopp Adler AG.

Copyright © Dürkopp Adler AG 2017

1	About these instructions	5
1.1	For whom are these instructions intended?	5
1.2	Representation conventions – symbols and characters	6
1.3	Other documents	7
1.4	Liability	8
2	Safety	9
2.1	Basic safety instructions	9
2.2	Signal words and symbols used in warnings	10
3	Machine description	15
3.1	Components of the machine	15
3.2	Proper use	16
3.3	Declaration of Conformity	17
4	Operation	19
4.1	Preparing the machine for operation	19
4.2	Switching on and off the machine	20
4.3	Switching on and off the sewing lamp	21
4.4	Inserting/changing the needle	22
4.4.1	In 1-needle machines	22
4.4.2	In 2-needle machines	24
4.5	Threading the needle thread	26
4.5.1	In 1-needle machines	26
4.5.2	In 2-needle machines	30
4.6	Winding the hook thread	36
4.7	Changing the bobbin	38
4.8	Thread tension	40
4.8.1	Setting the needle thread tension	41
4.8.2	Setting the hook thread tension	41
4.9	Setting the needle thread regulator	42
4.9.1	In 1-needle machines	42
4.9.2	In 2-needle machines	43
4.10	Lifting the sewing feet	44
4.11	Sewing backwards with the stitch adjustment lever (optional)	45
4.12	Setting quick stroke adjustment	46
4.13	Quick functions on the push buttons	47
4.13.1	Activating function buttons	47
4.13.2	Assigning a function to the favorite button	49
4.14	Sewing	50
5	Programming	53
5.1	Control panel OP3000	53
5.2	Switching on the machine	55

5.3	Software operating modes	57
5.4	Using Manual mode	58
5.4.1	Setting the quick access function (softkey menu).....	60
5.4.2	Setting the Speed parameter (<i>Max. Speed</i>)	64
5.4.3	Setting the Thread cutter parameter (<i>Thread Trim</i>).....	64
5.4.4	Setting the Thread clamp parameter (<i>Thread Clamp</i>).....	64
5.4.5	Setting the Initial alignment stitch parameter (<i>PointPos. °</i>).....	65
5.4.6	Setting the Start bartack parameter (<i>Start Tack</i>).....	65
5.4.7	Set End bartack parameter (<i>End Tack</i>).....	68
5.4.8	Setting the Sewing foot lift parameter (<i>Foot</i>)	70
5.4.9	Setting the Bobbin monitor parameter (<i>Bobbin</i>)	70
5.4.10	Setting the Information parameter (<i>Info</i>).....	73
5.4.11	Setting the Edge stop parameter (<i>Edge Guide</i>).....	74
5.4.12	Setting the Correction of effects of high speed parameter (<i>Speed Corr.</i>)	74
5.4.13	Setting the Material thickness detection parameter (<i>Fabric Thickness</i>).....	79
5.4.14	Setting the light barrier (<i>LightBarrier</i>) parameter.....	85
5.5	Using Automatic mode	87
5.5.1	Sewing in Automatic mode.....	88
5.5.2	Canceling a program in automatic mode.....	90
5.6	Using Programming/Edit mode	91
5.6.1	Creating a new program.....	91
5.6.2	Creating a program using keyboard input	92
5.6.3	Creating a program using Teach-In.....	94
5.6.4	Adjusting parameters for the current seam section.....	96
5.6.5	Adjusting parameters for the selected program	98
5.6.6	Editing programs	100
5.6.7	Copying the program.....	101
5.6.8	Deleting the program.....	103
6	Maintenance.....	105
6.1	Cleaning	106
6.2	Lubricating.....	108
6.2.1	Lubricating the machine head	109
6.2.2	Lubricating the hook	110
6.3	Servicing the pneumatic system.....	111
6.3.1	Setting the operating pressure	111
6.3.2	Draining the water condensation	113
6.3.3	Cleaning the filter element.....	114
6.4	Parts list.....	115
7	Setup	117
7.1	Checking the scope of delivery	117
7.2	Removing the transport locks.....	117

7.3	Assembling the stand	118
7.4	Assembling the pedal and setpoint device	119
7.5	Tabletop	120
7.5.1	Completing the tabletop	120
7.5.2	Assembling the tabletop to the stand	121
7.6	Setting the working height	122
7.7	Assembling the control	123
7.8	Inserting the machine head	124
7.9	Assembling the control panel	125
7.10	Assembling the knee button	126
7.11	Assembling the oil extraction line	127
7.12	Electrical connection	127
7.12.1	Connecting the sewing lamp transformer	128
7.12.2	Establishing equipotential bonding	130
7.12.3	Connecting the control	131
7.13	Pneumatic connection (optional)	131
7.13.1	Assembling the compressed air maintenance unit	132
7.13.2	Setting the operating pressure	133
7.14	Checking the lubrication	134
7.15	Performing a test run	135
8	Decommissioning	137
9	Disposal	139
10	Troubleshooting	141
10.1	Customer Service	141
10.2	Messages of the software	141
10.3	Errors in sewing process	142
11	Technical data	145
12	Appendix	149

1 About these instructions



These instructions have been prepared with utmost care. They contain information and notes intended to ensure long-term and reliable operation.

Should you notice any discrepancies or if you have improvement requests, then we would be glad to receive your feedback through **Customer Service** ( p. 141).

Consider the instructions part of the product and store them in a place where they are readily available.

1.1 For whom are these instructions intended?

These instructions are intended for:

- **Operators:**
This group is familiar with the machine and has access to the instructions. Specifically, chapter **Operation** ( p. 19) is important for the operators.
- **Specialists:**
This group has the appropriate technical training for performing maintenance or repairing malfunctions. Specifically, the chapter **Setup** ( p. 117) is important for specialists.

Service Instructions are supplied separately.

With regard to minimum qualification and other requirements to be met by personnel, please also follow the chapter **Safety** ( p. 9).

1.2 Representation conventions – symbols and characters

Various information in these instructions is represented or highlighted by the following characters in order to facilitate easy and quick understanding:



Proper setting

Specifies proper setting.



Disturbances

Specifies the disturbances that can occur from an incorrect setting.



Cover

Specifies which covers must be disassembled in order to access the components to be set.



Steps to be performed when operating the machine (sewing and equipping)



Steps to be performed for service, maintenance, and installation



Steps to be performed via the software control panel

The individual steps are numbered:

1. First step
 2. Second step
 - ...
- The steps must always be followed in the specified order.
- Lists are marked by bullet points.



Result of performing an operation

Change to the machine or on the display/control panel.



Important

Special attention must be paid to this point when performing a step.



Information

Additional information, e.g. on alternative operating options.



Order

Specifies the work to be performed before or after a setting.

References



Reference to another section in these instructions.

Safety Important warnings for the user of the machine are specifically marked. Since safety is of particular importance, hazard symbols, levels of danger and their signal words are described separately in the chapter **Safety** ( p. 9).

Location information If no other clear location information is used in a figure, indications of **right** or **left** are always from the user's point of view.

1.3 Other documents

The machine includes components from other manufacturers. Each manufacturer has performed a hazard assessment for these purchased parts and confirmed their design compliance with applicable European and national regulations. The proper use of the built-in components is described in the corresponding manufacturer's instructions.

1.4 Liability

All information and notes in these instructions have been compiled in accordance with the latest technology and the applicable standards and regulations.

Dürkopp Adler cannot be held liable for any damage resulting from:

- Breakage and damage during transport
- Failure to observe these instructions
- Improper use
- Unauthorized modifications to the machine
- Use of untrained personnel
- Use of unapproved parts

Transport

Dürkopp Adler cannot be held liable for breakage and transport damages. Inspect the delivery immediately upon receiving it. Report any damage to the last transport manager. This also applies if the packaging is not damaged.

Leave machines, equipment and packaging material in the condition in which they were found when the damage was discovered. This will ensure any claims against the transport company.

Report all other complaints to Dürkopp Adler immediately after receiving the product.

2 Safety

This chapter contains basic information for your safety. Read the instructions carefully before setting up or operating the machine. Make sure to follow the information included in the safety instructions. Failure to do so can result in serious injury and property damage.



2.1 Basic safety instructions

The machine may only be used as described in these instructions. The instructions should be available at the machine's location at all times.

Work on live components and equipment is prohibited. Exceptions are defined in the DIN VDE 0105.

For the following work, switch off the machine at the main switch or disconnect the power plug:

- Replacing the needle or other sewing tools
- Leaving the workstation
- Performing maintenance work and repairs
- Threading

Missing or faulty parts could impair safety and damage the machine. Only use original parts from the manufacturer.

Transport Use a lifting carriage or forklift to transport the machine. Raise the machine max. 20 mm and secure it to prevent it from slipping off.

Setup The connecting cable must have a power plug approved in the relevant country. The power plug may only be assembled to the power cable by qualified specialists.

Obligations of the operator Follow the country-specific safety and accident prevention regulations and the legal regulations concerning industrial safety and the protection of the environment.

All the warnings and safety signs on the machine must always be in legible condition. Do not remove!
Missing or damaged warnings and safety signs must be replaced immediately.

Requirements to be met by the personnel

Only qualified specialists may:

- set up the machine
- perform maintenance work and repairs
- perform work on electrical equipment

Only authorized persons may work on the machine and must first have understood these instructions.

Operation

Check the machine during operating for any externally visible damage. Stop working if you notice any changes to the machine. Report any changes to your supervisor. Do not use a damaged machine any further.

Safety equipment

Safety equipment should not be removed or deactivated. If it is essential to remove or deactivate safety equipment for a repair operation, it must be assembled and put back into operation immediately afterward.

2.2 Signal words and symbols used in warnings





Warnings in the text are distinguished by color bars. The color scheme is based on the severity of the danger. Signal words indicate the severity of the danger.

Signal words Signal words and the hazard they describe:

Signal word	Meaning
DANGER	(with hazard symbol) If ignored, fatal or serious injury will result
WARNING	(with hazard symbol) If ignored, fatal or serious injury can result

CAUTION	(with hazard symbol) If ignored, moderate or minor injury can result
CAUTION	(with hazard symbol) If ignored, environmental damage can result
NOTICE	(without hazard symbol) If ignored, property damage can result

Symbols The following symbols indicate the type of danger to personnel:

Symbol	Type of danger
	General
	Electric shock
	Puncture
	Crushing
	Environmental damage

Examples Examples of the layout of warnings in the text:

DANGER



Type and source of danger!
Consequences of non-compliance.
Measures for avoiding the danger.

↪ This is what a warning looks like for a hazard that will result in serious injury or even death if ignored.

WARNING



Type and source of danger!
Consequences of non-compliance.
Measures for avoiding the danger.

↪ This is what a warning looks like for a hazard that could result in serious or even fatal injury if ignored.

CAUTION



Type and source of danger!
Consequences of non-compliance.
Measures for avoiding the danger.

↪ This is what a warning looks like for a hazard that could result in moderate or minor injury if the warning is ignored.

NOTICE

Type and source of danger!

Consequences of non-compliance.

Measures for avoiding the danger.

- ↪ This is what a warning looks like for a hazard that could result in property damage if ignored.

CAUTION



Type and source of danger!

Consequences of non-compliance.

Measures for avoiding the danger.

- ↪ This is what a warning looks like for a hazard that could result in environmental damage if ignored.

3 Machine description

3.1 Components of the machine

Fig. 1: Components of the machine

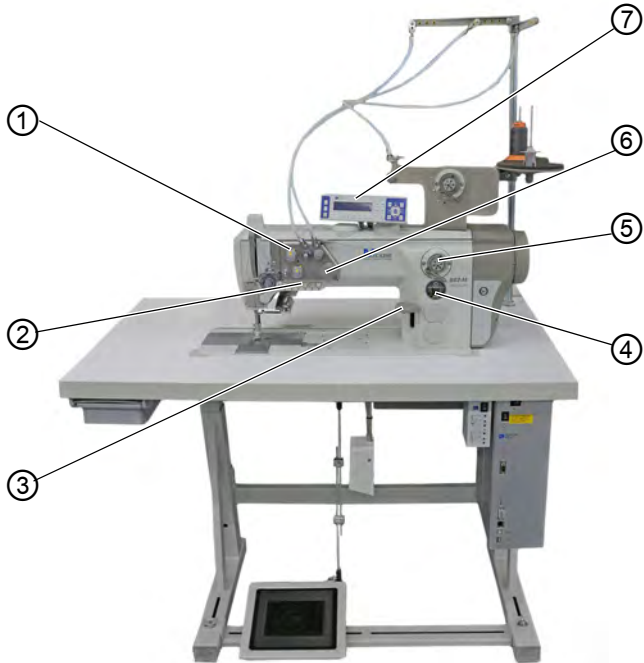

- | | |
|-----------------------------------|----------------------------|
| (1) - Programmable thread tension | (4) - Oil level indicator |
| (2) - Push buttons | (5) - Winder |
| (3) - Stitch adjustment lever | (6) - Electronic handwheel |
| | (7) - Control panel OP3000 |

3.2 Proper use

WARNING



Risk of injury from live, moving and cutting parts as well as from sharp parts!

Improper use can result in electric shock, crushing, cutting and punctures.

Follow all instructions provided.

NOTICE

Non-observance will lead to property damage!

Improper use can result in material damage at the machine.

Follow all instructions provided.

The machine may only be used with sewing material that satisfies the requirements of the specific application at hand.

The machine is intended only for use with dry sewing material. The sewing material must not contain any hard objects.

The needle thicknesses permissible for the machine are listed in the **Technical Data** (📖 p. 145) chapter.

The seam must be completed with a thread that satisfies the requirements of the specific application at hand.

The machine is intended for industrial use.

The machine may only be set up and operated in dry conditions on well-maintained premises. If the machine is operated on premises that are not dry and well-maintained, then further measures may be required which must be compatible with DIN EN 60204-31.

Only authorized persons may work on the machine.

Dürkopp Adler cannot be held liable for damages resulting from improper use.

3.3 Declaration of Conformity

The machine complies with European regulations ensuring health, safety, and environmental protection as specified in the declaration of conformity or in the declaration of incorporation.



4 Operation

The operating sequence consists of several different steps. Fault-free operation is necessary in order to achieve a good sewing result.

4.1 Preparing the machine for operation

WARNING



Risk of injury from moving, cutting and sharp parts!

Crushing, cutting and punctures are possible.

If possible, make preparations only when the machine is switched off.

Complete the following steps in preparation of sewing before starting to work:

- Inserting/changing the needle
- Threading the needle thread
- Inserting and winding on the hook thread
- Setting the thread tensions

4.2 Switching on and off the machine

Fig. 2: Switching on and off the machine

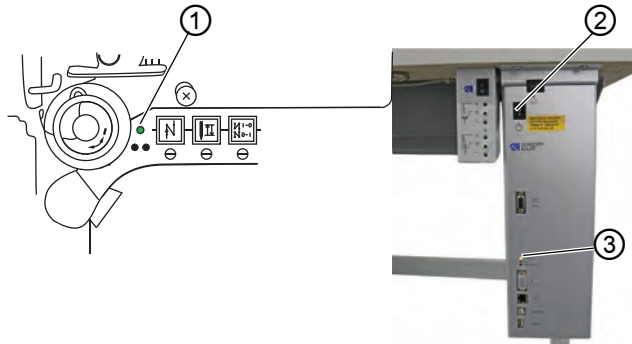

(1) - Indicator LED
(2) - Switch

(3) - POWER LED

Switching on the machine



To switch on the machine:

1. Press the switch (2) to the **I** position.
- ☞ The indicator LED (1) and the POWER LED (3) illuminate.

Switching off the machine



To switch off the machine:

1. Press the switch (2) to the **O** position.
2. The indicator LED (1) and the POWER LED (3) go out.

4.3 Switching on and off the sewing lamp

The sewing lamp switches on and off independent of the main switch.

Fig. 3: Switching on and off the sewing lamp

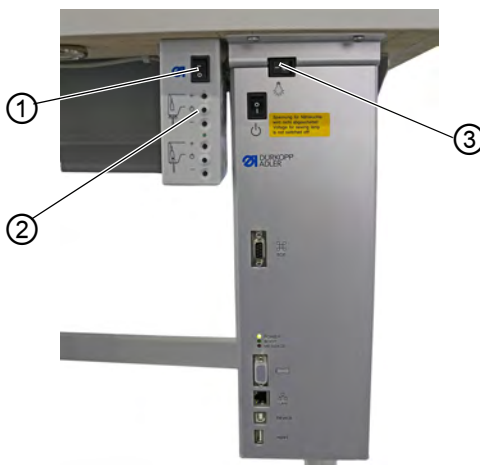

(1) - Switch

(2) - Button

(3) - Switch

Switching on the dimmable sewing lamp



To switch on the dimmable sewing lamp:

1. Press the switch (3) to the **I** position.
 2. Press the switch (1) to the **I** position.
- ↳ The dimmable sewing lamp illuminates.
Press button (2) if the sewing lamp is not yet illuminated.

Switching off the dimmable sewing lamp



To switch off the dimmable sewing lamp:

1. Press switch (1) or (3) to the **O** position.
- ↳ The dimmable sewing lamp goes out.

4.4 Inserting/changing the needle

CAUTION



Risk of injury from sharp parts!

Punctures possible.

Switch off the machine before you insert or change the needle.

NOTICE

Property damage may occur!

There is a risk of machine damage, needle breakage or thread breakage if the distance between needle and hook tip is incorrect.

Check the distance to the hook tip after inserting a needle with a different thickness.

4.4.1 In 1-needle machines

Fig. 4: Inserting/changing the needle

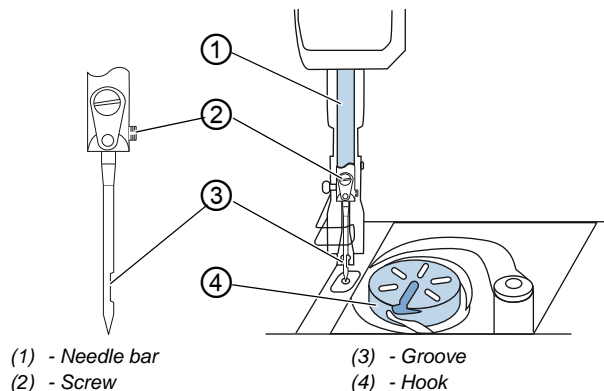

To change the needle in a 1-needle machine:



1. Turn the handwheel until the needle bar (1) reaches the upper end position.
2. Loosen the screw (2).

3. Pull the needle out towards the bottom.
4. Insert the new needle into the hole in the needle bar (1) until it reaches the end stop.

**Important**

- Align the needle in such a way that the groove (3) faces the hook (4).
5. Tighten the screw (2).

**Order**

Always adjust the clearance between the hook and the needle after changing to a different needle thickness ( *Service Instructions*).

**Disturbance**

An incorrect hook distance can cause the following disturbances:

- Changing to a thinner needle:
 - Missing stitches
 - Thread damage
- Changing to a thicker needle:
 - Damage to the hook tip
 - Damage to the needle

4.4.2 In 2-needle machines

Fig. 5: Inserting/changing the needle (2)

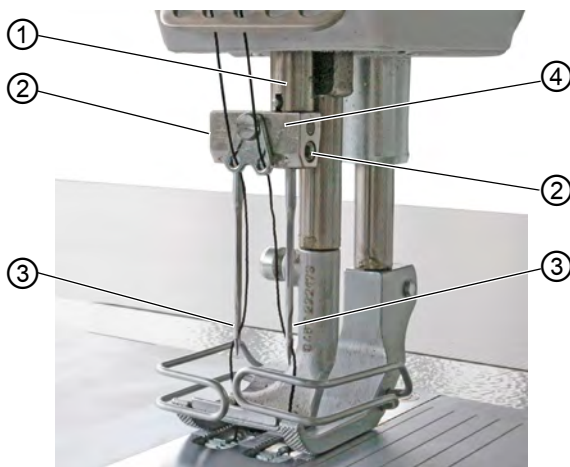

(1) - Needle bar
(2) - Screw

(3) - Groove
(4) - Needle holder

To change the needle in a 2-needle machine:



1. Turn the handwheel until the needle bar (1) has reached the upper end position.
2. To change the right needle, loosen the right screw (2).
3. To change the left needle, loosen the left screw (2).
4. Pull the needles downwards out of the needle holder (4).
5. Insert each new needle into the corresponding hole of the needle holder (4) until it reaches the stop.

Important

Align the new needles in such a way that the grooves (3) face the hook (4). As viewed from the operator side, the groove (3) of the left needle must point to the left, while the groove (3) of the right needle must point to the right.

6. Tighten the screw (2).



Order

Always adjust the clearance between the hook and the needle after changing to a different needle thickness (📖 *Service Instructions*).



Disturbance

An incorrect hook distance can cause the following disturbances:

- Changing to a thinner needle:
 - Missing stitches
 - Thread damage
- Changing to a thicker needle:
 - Damage to the hook tip
 - Damage to the needle

4.5 Threading the needle thread

WARNING



Risk of injury from needle tip and moving parts!

Puncture, cutting and crushing possible.

Turn off the machine before threading the thread.

4.5.1 In 1-needle machines

Fig. 6: Threading the needle thread (1-needle machine) (1)

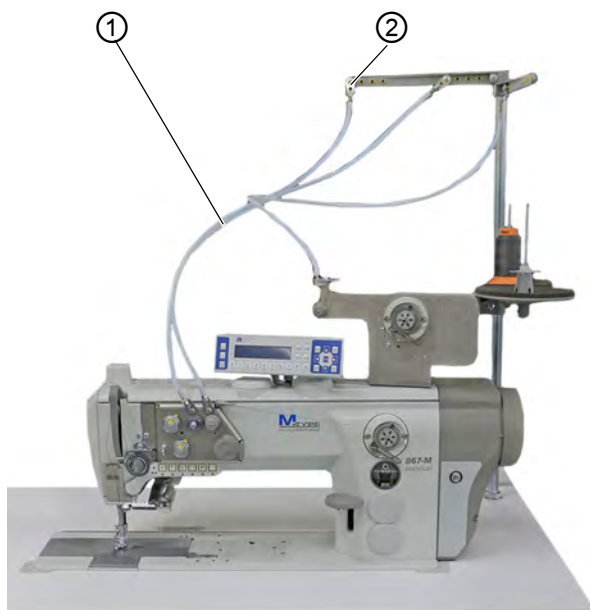

(1) - Hose guide

(2) - Thread guide

To thread the needle thread:



1. Fit the thread reel on the reel stand.

The unwinding bracket must stand directly above the thread reel.

2. Feed the thread from the rear to the front through the thread guide (2) on the unwinding bracket.
3. Use compressed air to blow the thread through the hose guide (1).



Information

To blow the thread through the hose guide (1) with the help of compressed air, position the compressed air gun together with the end of the thread at the upper end of the hose guide (1). Briefly squeeze the trigger once.

Fig. 7: Threading the needle thread (1-needle machine) (2)

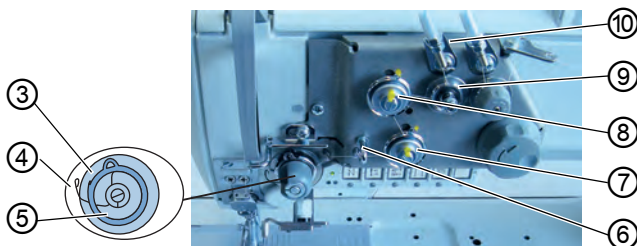

- | | |
|-----------------------------|---------------------|
| (3) - Tightening lever | (7) - Tensioner 2 |
| (4) - Spring tip | (8) - Tensioner 1 |
| (5) - Thread tension spring | (9) - Pre-tensioner |
| (6) - Thread guide | (10) - Hose guide |



4. Feed the thread clockwise from the hose guide (10) around the pre-tensioner (9).
5. Feed the thread counterclockwise around tensioner 1 (8).
6. Feed the thread clockwise around tensioner 2 (7).
7. Feed the thread under the thread guide (6) to the thread tension spring (5).
8. Lift the tightening lever (3) with the thread.
9. Pull the thread under the spring tip (4).

Fig. 8: Threading the needle thread (1-needle machine) (3)

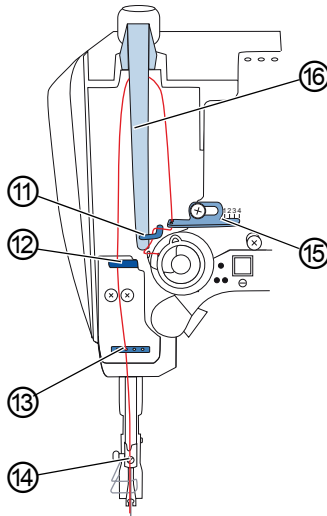

- | | |
|--------------------------|-------------------------------|
| (11)- Hook | (14)- Thread guide |
| (12)- Upper thread guide | (15)- Needle thread regulator |
| (13)- Lower thread guide | (16)- Thread lever |



10. Guide the thread under the hook (11).
11. Insert the thread from bottom to top through the hole on the needle thread regulator (15).
12. Insert the thread from the right to the left through the thread lever (16).
13. Insert the thread through the upper thread guide (12).
14. Insert the thread through a hole in the lower thread guide (13).



For machines with thread clamp (optional)

15. Insert the thread through the left hole of the guide above the thread clamp.
16. Insert the thread through the left hole of the guide below the thread clamp.

Fig. 9: Thread clamp

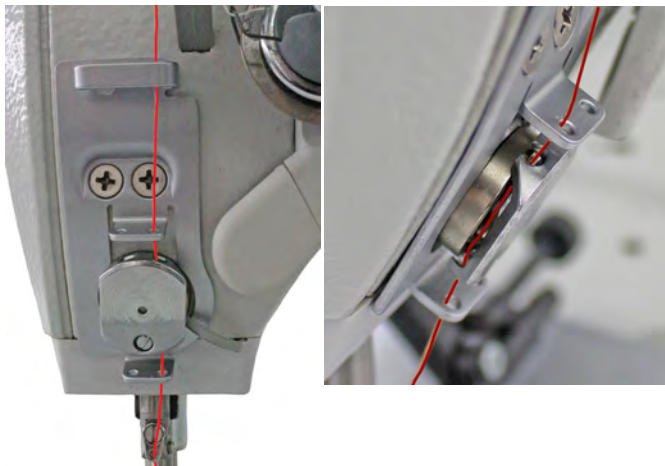

17. Insert the thread into the thread clamp from the left so that the thread is held in place inside the hook of the clamp.

The thread is supposed to run through the clamp almost without touching it and in such a way that it only makes contact with the guides above and below the thread clamp.

18. Feed the thread through the thread guide (14) on the needle bar.
19. Insert the thread through the needle eye in such a way that the loose thread end faces the hook.
-



For machines with thread cutter

20. Pull the thread through the needle eye until the loose thread end has a length of approx. 4 cm with the thread lever (16) at the highest position.

Important:

Check the thread length.

If the loose thread end is too long, the thread may be caught by the hook and cause a disturbance. If the loose thread end is too short, the machine cannot start sewing.

4.5.2 In 2-needle machines

Fig. 10: Threading the needle thread (2-needle machine) (1)

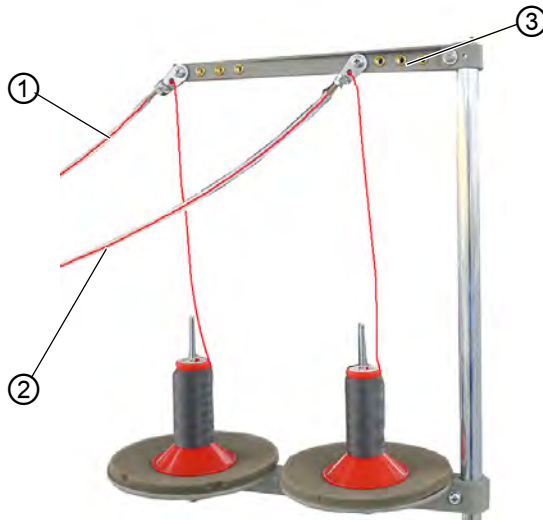

(1) - Left hose guide
(2) - Right hose guide

(3) - Unwinding bracket

To thread the right and the left needle thread:

Threading the needle thread through the hose guides:



1. Fit the thread reels on the reel stands.
The unwinding bracket (3) must stand directly above the thread reels.
2. Feed the right thread from the rear to the front to the right hose guide (2).
3. Feed the left thread from the rear to the front to the left hose guide (1).
4. Use compressed air to blow both threads through the hose guides (1) and (2).



Information

To blow the threads through hose guide (1) and (2) with the help of compressed air, position the compressed air gun together with the end of the threads at the upper end of hose guide (1) and (2). Briefly squeeze the trigger once.

Threading the right needle thread at the tensioning plate

Fig. 11: Threading the needle thread (2-needle machine) (2)

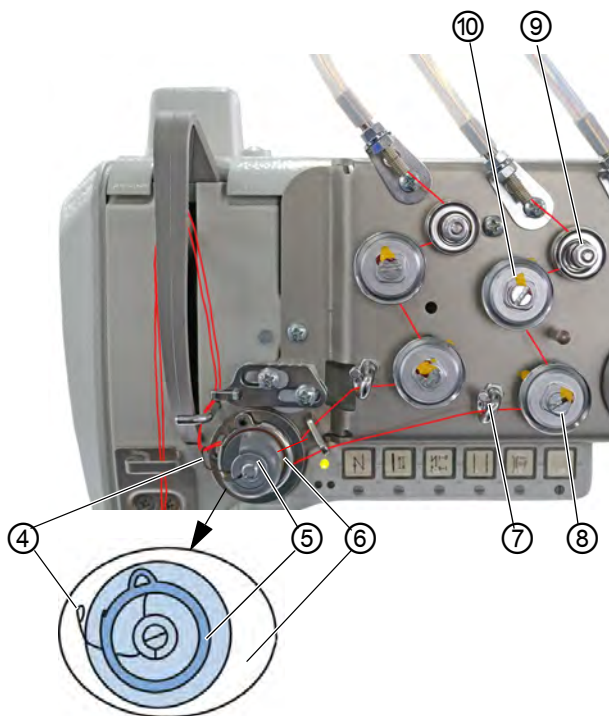

- | | |
|--|--|
| (4) - Spring tip | (9) - Pre-tensioner
(right needle thread) |
| (5) - Thread tension spring | (10) - Tensioner
(right needle thread) |
| (6) - Tightening lever | |
| (7) - Thread guide (right needle thread) | |
| (8) - Tensioner (right needle thread) | |



5. Feed the thread clockwise from the right hose guide (2) around the pre-tensioner (9).
6. Feed the thread counterclockwise around the tensioner (10).
7. Feed the thread clockwise around the tensioner (8).
8. Feed the thread under the thread guide (7) clockwise to the thread tension spring (5).
9. Lift the tightening lever (6) with the thread.
10. Pull the thread under the spring tip (4).

Threading the left needle thread at the tensioning plate

Fig. 12: Threading the needle thread (2-needle machine) (3)

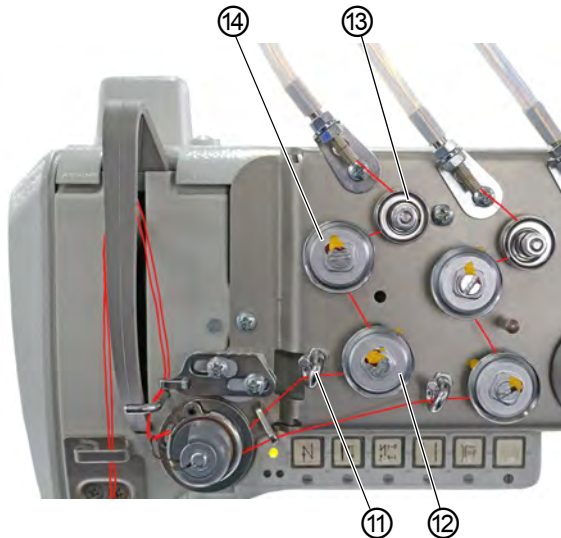

(11)- Thread guide
(left needle thread)

(12)- Tensioner (left needle thread)

(13)- Pre-tensioner (left needle thread)

(14)- Tensioner (left needle thread)



11. Feed the thread clockwise from the left hose guide (1) around the pre-tensioner (13).
12. Feed the thread counterclockwise around the tensioner (12).
13. Feed the thread clockwise around the tensioner (14).

14. Feed the thread under the thread guide (11) clockwise to the thread tension spring (5).
15. Lift the tightening lever (6) with the thread.
16. Pull the thread under the spring tip (4).

Threading the needle thread at the needle thread regulator

Fig. 13: Threading the needle thread (2-needle machine) (4)

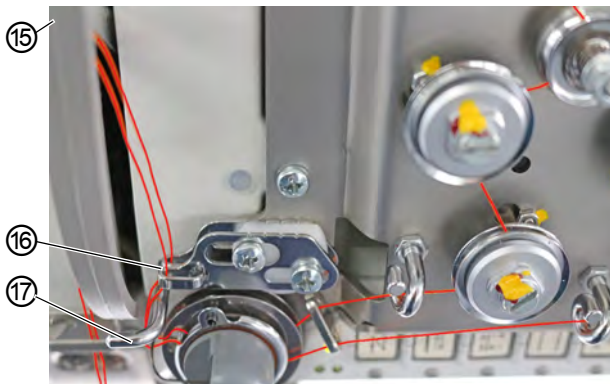

(15)- Thread lever (now visible) (17)- Hook
(16)- Needle thread regulator

17. Guide the right thread under the hook (17).
18. Guide the left thread under the hook (17).
19. Thread the right thread from the bottom through the front hole on the needle thread regulator (16).
20. Thread the left thread from the bottom through the rear hole on the needle thread regulator (16).
21. Thread the right thread from the right through the lower hole on the thread lever (15).
22. Thread the left thread from the right through the upper hole on the thread lever (15).

Fig. 14: Threading the needle thread (2-needle machine) (5)

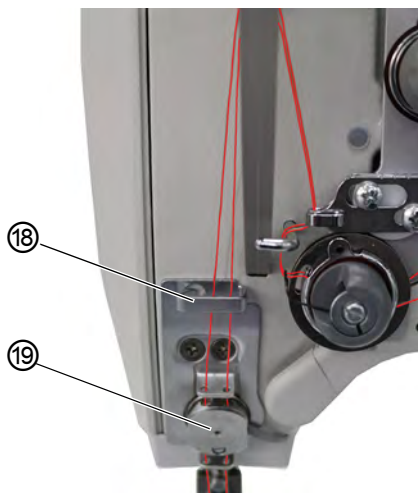

(18)- Thread guide

(19)- Thread clamp

23. Insert the right and the left thread through the upper thread guide (18).

For machines with thread clamp (optional):

24. Insert the right thread through the right hole of the guide above the thread clamp (19).
 25. Insert the left thread through the left hole of the guide above the thread clamp (19).
 26. Insert the right thread through the right hole of the thread clamp (19).
The thread is supposed to run through the clamp almost without touching it and in such a way that it only makes contact with the guides above and below the thread clamp (19).
 27. Insert the right thread through the right hole of the guide below the thread clamp (19).
 28. Insert the left thread through the left hole of the guide below the thread clamp (19).
-

Fig. 15: Threading the needle thread (2-needle machine) (6)

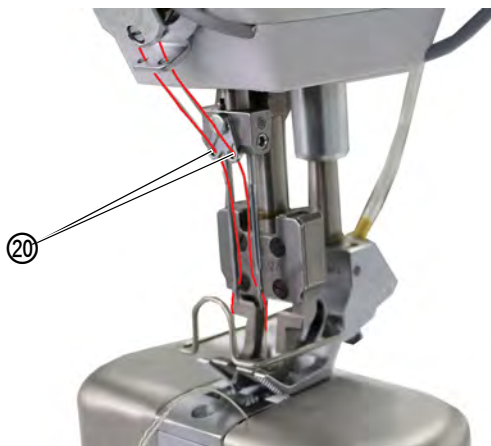

(20)- Thread guide



29. Insert the right thread through the right hole of the thread guide (20) on the needle bar.
30. Insert the left thread through the left hole of the thread guide (20) on the needle bar.
31. Insert the right thread through the right needle eye in such a way that the loose thread end faces the right hook.
32. Insert the left thread through the left needle eye in such a way that the loose thread end faces the left hook.



For machines with thread cutter

33. Pull each thread through the needle eye until the loose thread end has a length of approx. 4 cm with the thread lever (15) at the highest position.



Important

Check the thread length.

If the loose thread end is too long, the thread may be caught by the hook and cause a disturbance. If the loose thread end is too short, the machine cannot start sewing.

4.6 Winding the hook thread

WARNING



Risk of injury from needle tip and moving parts!

Puncture, cutting and crushing possible.

Turn off the machine before threading the thread.

Fig. 16: Winding the hook thread (1)

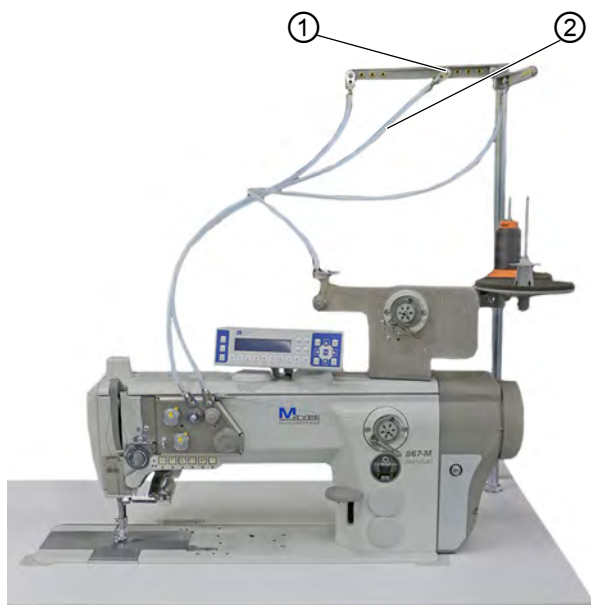

(1) - Thread guide

(2) - Hose guide

To wind the hook thread:



1. Fit the thread reel on the reel stand.

The unwinding bracket must stand directly above the thread reel.

2. Feed the thread from the rear to the front through the thread guide (1) on the unwinding bracket.
3. Use a compressed air gun to feed the thread through the hose guide (2).

Fig. 17: Winding the hook thread (2)

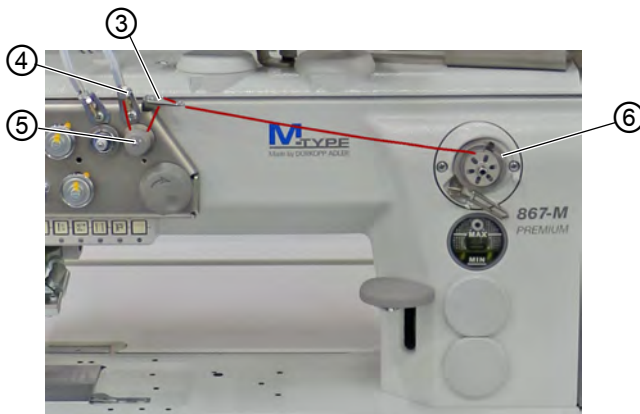

- | | |
|--------------------|---------------------|
| (3) - Thread guide | (5) - Pre-tensioner |
| (4) - Thread guide | (6) - Winder |



4. Feed the thread counterclockwise from the thread guide (4) around the pre-tensioner (5).
5. Insert the thread in a wavelike manner through the 2 holes of the thread guide (3): from bottom to top through the left hole and from top to bottom through the right hole.
6. Guide the thread to the bobbin (6).

Fig. 18: Winding the hook thread (3)

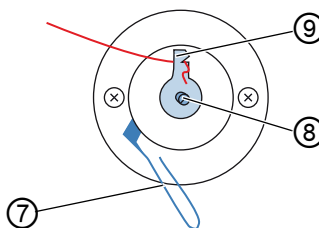

- | | |
|--------------------|--------------|
| (7) - Bobbin lever | (9) - Cutter |
| (8) - Bobbin shaft | |



7. Clamp the thread behind the cutter (9) and tear off the loose end behind it.
8. Fit the bobbin on the bobbin shaft (8).
9. Turn the bobbin clockwise until it clicks.
10. Pull the bobbin lever (7) up.



Information

The hook thread is normally wound on when sewing is in progress. However, you can also wind on the hook thread without sewing, e. g. if you require a full bobbin in order to start sewing. For this purpose, use the winder mode in the softkey menu ( p. 60).



11. Switch on the sewing machine.

12. Press the pedal forwards.

 The machine sews and winds the hook thread from the thread reel onto the bobbin. When the bobbin is filled, the winding process stops. The bobbin lever moves down. The cutter is automatically moved into its basic vertical position.

13. Pull off the full bobbin.

14. Tear off the thread behind the cutter (9).

15. Insert the full bobbin into the hook ( p. 38).

4.7 Changing the bobbin

WARNING



Risk of injury from needle tip and moving parts!

Puncture, cutting and crushing possible.

Turn off the machine before changing the bobbin.

The procedure used to change the bobbin is the same for 1-needle machines and 2-needle machines. The only difference is that the hook into which the bobbin is inserted is turned by 180 degrees for the left and the right side.

Fig. 19: Changing the bobbin

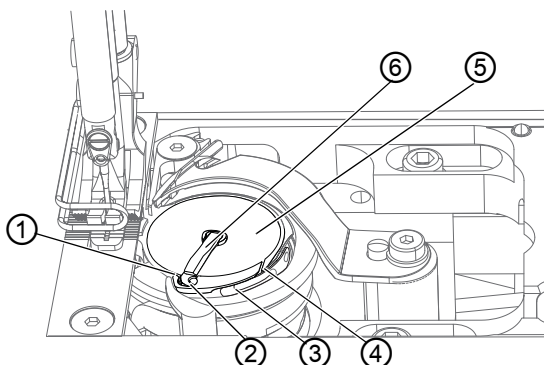

- | | |
|----------------------|----------------------------|
| (1) - Slot | (4) - Slot |
| (2) - Guide | (5) - Bobbin |
| (3) - Tension spring | (6) - Bobbin case retainer |

To change the bobbin:



1. Swivel up the bobbin case retainer (6).
2. Remove the empty bobbin.
3. Insert a full bobbin:



Important

Insert the bobbin so that it moves in the opposite direction of the hook when the thread is pulled out.

4. Feed the hook thread through the slot (4) in the bobbin case retainer.
5. Pull the hook thread under the tension spring (3).
6. Feed the hook thread through the slot (1) and pull it approx. 3 cm further.
7. Close the bobbin case retainer (6).



Machines with automatic remaining thread monitor

If the hook thread needs to be replaced, the LED indicator lamps (7) light up on the machine arm. The left light is for the left-hand hook, and the right light is for the right-hand hook.

Fig. 20: Remaining thread monitor message

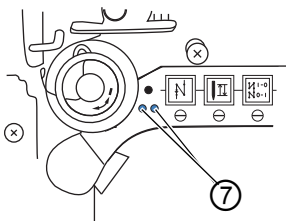

(7) - LEDs

(8) -



Important

Each of the bobbins has a thread supply groove that is embedded in the bobbin core.

Insert the bobbin in the hook in such a way that the thread supply groove faces down. Otherwise, the remaining thread monitor will not work.

4.8 Thread tension

Together with the hook thread tension, the needle thread tension influences the final seam pattern. With thin sewing material, excessive thread tension can lead to undesired gathering and thread breakage.



Proper setting

If the tension of needle thread and hook thread is identical, the thread interlacing lies in the middle of the sewing material. Set the needle thread tension so that the desired seam pattern is achieved with the lowest possible tension.

Fig. 21: Thread tension

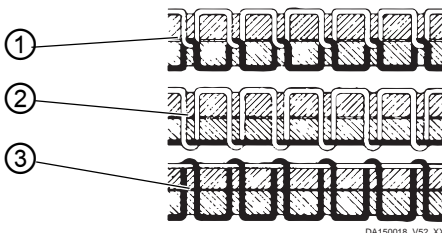

DA150018_V52_XX

(1) - Identical needle thread and hook thread tension

(2) - Hook thread tension higher than needle thread tension

(3) - Needle thread tension higher than hook thread tension

4.8.1 Setting the needle thread tension

The needle thread tension can only be set using the software of the OP3000; for detailed information, refer to the chapter Programming (📖 p. 53).

4.8.2 Setting the hook thread tension

WARNING



Risk of injury from needle tip and moving parts!

Puncture, cutting and crushing possible.

Switch off the machine before adjusting the hook thread tension.

Fig. 22: Setting the hook thread tension

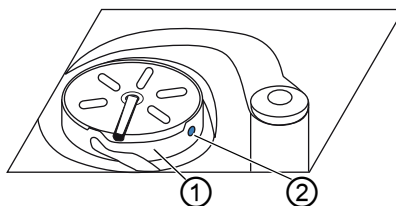

(1) - Tension spring

(2) - Screw

The hook thread tension is generated by the tension spring (1) and adjusted via the screw (2).

To set the hook thread tension:

Increasing the hook thread tension



1. Turn screw (2) clockwise.

Reducing the hook thread tension



1. Turn screw (2) counterclockwise.

4.9 Setting the needle thread regulator

WARNING



Risk of injury from needle tip and moving parts!

Puncture, cutting and crushing possible.

Switch off the machine before setting the needle thread regulator.

The needle thread regulator determines the tension applied to guide the needle thread around the hook.



Proper setting

The loop of the needle thread slides at low tension over the thickest point of the hook.

4.9.1 In 1-needle machines

Fig. 23: Setting the needle thread regulator

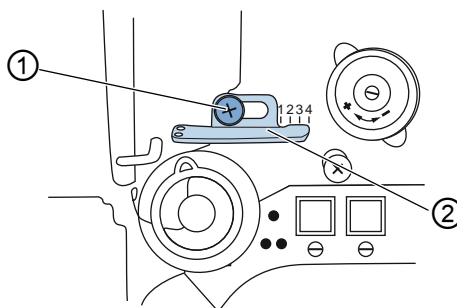

(1) - Screw

(2) - Needle thread regulator

To set the needle thread regulator:



1. Loosen the screw (1).
 - **To increase the tension:**
Slide the needle thread regulator (2) to the right
 - **To reduce the tension:**
Slide the needle thread regulator (2) to the left
2. Tighten the screw (1).

4.9.2 In 2-needle machines

Fig. 24: Setting the needle thread regulator (2)

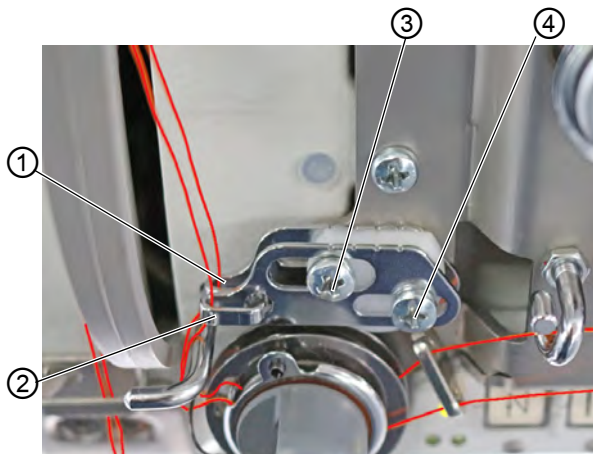

- | | |
|--|-----------------------------------|
| (1) - Needle thread regulator
(left needle thread) | (3) - Screw (left needle thread) |
| (2) - Needle thread regulator
(right needle thread) | (4) - Screw (right needle thread) |

To set the needle thread regulator for the right and the left needle thread in a 2-needle machine:



1. To set the needle thread regulator (2) for the right needle thread: Loosen the screw (4).
 - **To increase the tension:**
Slide the needle thread regulator (2) to the right.
 - **To reduce the tension:**
Slide the needle thread regulator (2) to the left.
2. Tighten the screw (4).
3. To set the needle thread regulator (1) for the left needle thread: Loosen the screw (3).
 - **To increase the tension:**
Slide the needle thread regulator (1) to the right.
 - **To reduce the tension:**
Slide the needle thread regulator (1) to the left.
4. Tighten the screw (3).



Information

When the largest thread quantity is required, the thread tension spring must be pulled approx. 0.5 mm up from its lower end position. This occurs when the needle thread loop passes the maximum hook diameter.

4.10 Lifting the sewing feet

Fig. 25: Lifting the sewing feet

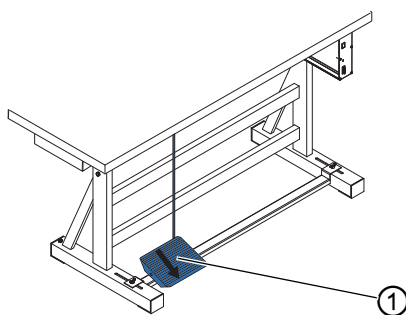

(1) - Pedal

To lift the sewing feet:



1. Press the pedal (1) halfway back.

↳ The machine stops and lifts the sewing feet.
The sewing feet remain up as long as the pedal is pressed halfway back.

or



1. Press the pedal (1) fully back.

↳ The thread cutter is activated, and the sewing feet are raised.

4.11 Sewing backwards with the stitch adjustment lever (optional)

The electronic stitch adjustment lever on the machine arm reduces the stitch length down to sewing backwards in the lower end position.

Fig. 26: Sewing backwards with the stitch adjustment lever



(1) - Stitch adjustment lever



1. Slowly push the stitch adjustment lever (1) down.
↳ The stitch length becomes smaller. In the lower end position, the machine sews backwards with the set stitch length.

4.12 Setting quick stroke adjustment

On machines with quick stroke adjustment the elevated sewing foot stroke is switched via the knee button. The toggle switch on the rear side of the knee button determines whether the elevated sewing foot stroke is switched on permanently or only while the knee button is pressed.

Fig. 27: Setting quick stroke adjustment

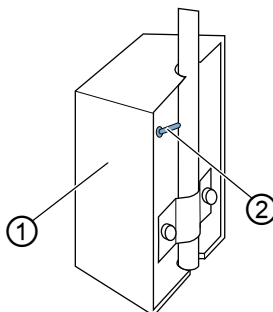

(1) - Knee button

(2) - Toggle switch

To set the quick stroke adjustment:

For permanent conversion



1. Set the toggle switch (2) to the upper position.
 - **To switch on the elevated sewing foot stroke:**
Push the knee button (1) to the right.
 - **To switch off the elevated sewing foot stroke:**
Push the knee button (1) to the right again.

For temporary conversion



1. Set the toggle switch (2) to the lower position.
 - **To switch on the elevated sewing foot stroke:**
Push the knee button (1) to the right and keep it pressed.
- ↳ The elevated sewing foot stroke is retained as long as the knee button is pushed to the right.
 - **To switch off the elevated sewing foot stroke:**
Release the knee button (1).

4.13 Quick functions on the push buttons

The machine has push buttons on the machine arm which can be used to activate specific functions while sewing.

4.13.1 Activating function buttons

Fig. 28: Activating function buttons

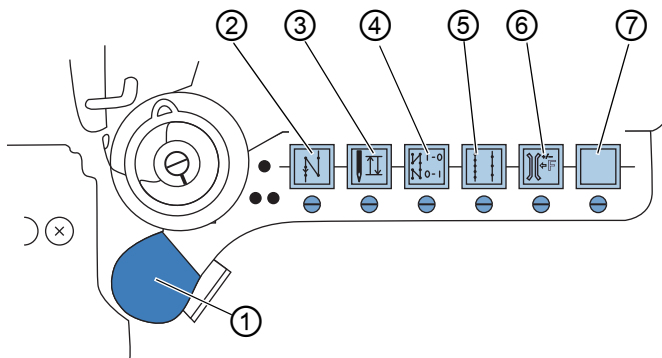

- | | |
|---------------------------------|----------------------------------|
| (1) - Favorite button | (5) - Stitch length preselection |
| (2) - Sewing backwards | (6) - Auxiliary thread tension |
| (3) - Needle position | (7) - fully customizable button |
| (4) - Start bartack/end bartack | |

To activate/deactivate a function button:

Activating a function



1. Press the desired button.
 Function is activated. The button lights up.

Deactivating a function









1. Press the desired button again.
 Function is deactivated. The button turns off.



Information

The function buttons can be expanded by an additional button. The button can be assigned 2 additional functions.

Functions of the buttons

Button	Function
	<p>Sewing backwards When this button is activated, the machine sews in reverse.</p>
	<p>Needle position When this button is activated, the needle moves to a specific position. This position is determined individually via the parameter settings. For more information, refer to the  Service Instructions. The machine comes configured so that selecting the button will bring the needle up to the top dead center.</p>
	<p>Start bartack/end bartack This button cancels the general setting for sewing start and end bartacks. If bartacks are on, pressing the button skips the next bartack. If bartacks are off, pressing the button sews the next bartack.</p>
	<p>Stitch length When this button is selected, the machine sews with the greater stitch length that was programmed for this stitch length on the control panel.</p>
	<p>Auxiliary thread tension When this button is selected, the machine sews with the programmed auxiliary thread tension.</p>
	<p>Fully customizable The button is fully customizable. The machine comes configured so that the machine will switch to the next seam section when the button is pressed.</p>

4.13.2 Assigning a function to the favorite button

You can assign one of the button functions to the favorite button. Select a function that you frequently use so that you can switch it on faster while sewing.

Fig. 29: Assigning a function to the favorite button

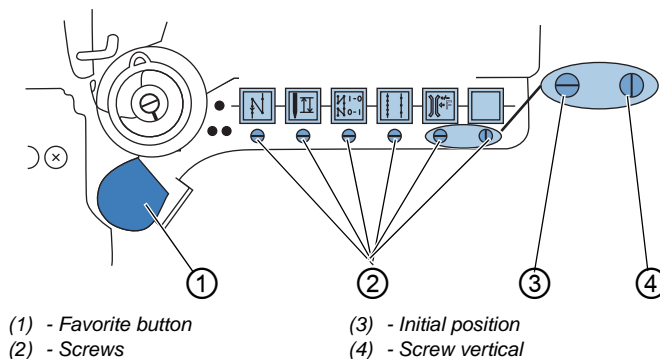

The button function is assigned by turning the screw (2) under the button until it is vertical. Only one function at a time can be assigned to the favorite button (1). Therefore, only one of the screws (2) may be in the vertical position (4).

All screws must be turned back to their horizontal initial position (3) before a new function is assigned.

To assign a function to the favorite button:



1. Turn all screws to their initial position (3) so that the slots of the screws are horizontal.
2. Turn the screw (2) under the desired button 90° so that the slot is vertical (4).

4.14 Sewing

WARNING



Risk of injury from the needle if sewing is started unintentionally!

Punctures possible.

Do not press the pedal when you fingers are in the area of the needle tip.

Fig. 30: Sewing

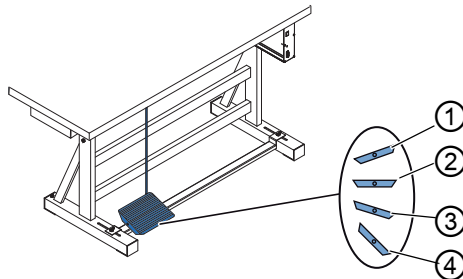

(1) - Position +1
(2) - Position 0

(3) - Position -1
(4) - Position -2

The pedal starts and controls the sewing process.

Condition	Processes
Before starting sewing	
Initial situation	<ul style="list-style-type: none"> • Pedal in rest position (position 0) ↳ Machine is at a standstill ↳ Needle is up. Sewing feet down.
Position the sewing material	<ul style="list-style-type: none"> • Press the pedal halfway back (position -1) ↳ The sewing feet are lifted. • Position the sewing material. • Release the pedal. ↳ Sewing feet are lowered onto the sewing material.

Condition	Processes
At seam beginning	
Start bartack and sew	<ul style="list-style-type: none"> • Press the pedal forwards (position +1) and keep it there. ↳ Machine sews a start bartack (if specified). ↳ Afterwards, the machine continues to sew - with increasing speed the further forward the pedal is pressed.
In the middle of the seam	
Stopping sewing	<ul style="list-style-type: none"> • Release the pedal (position 0). ↳ Machine stops. Depending on the setting, sewing feet and needle are up / down.
Continue the sewing process (after releasing the pedal)	<ul style="list-style-type: none"> • Press the pedal forwards (position +1) ↳ Machine continues to sew - with increasing speed the further forward the pedal is pressed.
Sew over thicker parts of the material	<ul style="list-style-type: none"> • Switch on the elevated sewing foot stroke with the knee button (📖 p. 46).
Change the stitch length	<ul style="list-style-type: none"> • 2nd stitch length must be activated using the button on the push buttons (📖 p. 47).
Increase the thread tension	<ul style="list-style-type: none"> • Activate auxiliary thread tension using the button on the push buttons (📖 p. 47).
Sew an intermediate bartack	<ul style="list-style-type: none"> • Sew backwards with stitch adjustment lever (📖 p. 45) or activate backwards sewing using the button on the push buttons (📖 p. 47).
At seam end	
Finish the seam and remove the sewing material	<ul style="list-style-type: none"> • Press the pedal fully back (position -2) and keep it there. ↳ End bartack is sewn, and thread is cut (if set). ↳ Machine stops. ↳ Needle is up. Sewing feet up. • Remove the sewing material.

5 Programming

5.1 Control panel OP3000

Fig. 31: Control panel













(1) - Softkey button

(2) - Softkey menu button

All settings in the software for the 867-M PREMIUM are performed using the OP3000 control panel.

Button	Function
Numeric buttons 0 to 9	<ul style="list-style-type: none"> • Inputting the parameter value (if the field for the parameters is activated) • Selection of a parameter that is shown on the control panel • Press the button below the desired symbol to select the function • Inputting a program name
	<ul style="list-style-type: none"> • Cancel the function • Exit the menu (changes remain saved) to return to the starting level
	<ul style="list-style-type: none"> • Confirm the settings • Activate the input
	Function is different for each menu.
	Function is different for each menu.

Button	Function
	Function is different for each menu.
	<ul style="list-style-type: none"> • Selection to the right
	<ul style="list-style-type: none"> • Selection to the left • Back one menu level
	<ul style="list-style-type: none"> • Increase the value • Scroll through the list (upwards)
	<ul style="list-style-type: none"> • Decrease the value • Scroll through the list (downwards)
	Softkey button The button can be assigned various functions as required,  p. 60.
	Softkey menu button Quick access function,  p. 60.
	No function assigned

Display on the control panel

The display shows the menu items that can be selected. The activated menu point is shown inverted.

Fig. 32: The active entry is shown inverted (example)

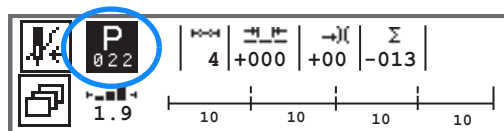

Entering values

Values can be entered using the ▲/▼ buttons or the numeric buttons.



Information

If a value is entered that is not within the specified value range, the software will automatically adopt the limit value which is closest to your entry from the value range.

5.2 Switching on the machine

Fig. 33: Switching on the machine



(1) - Main switch



To switch on the machine:

1. Switch on the main switch (1).
- ↳ The display briefly shows the software versions:

Fig. 34: Display of the control/control panel software version

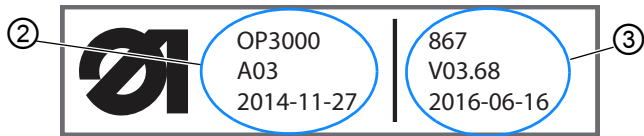

(2) - Software version of the OP3000 (3) - Control panel software

- ↪ The machine performs a reference run:
The display shows the program last used, or Manual mode.

Fig. 35: Display of the program last used (Automatic mode)

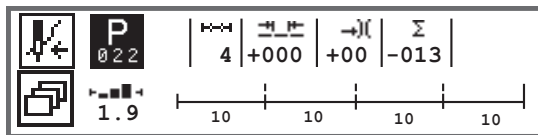
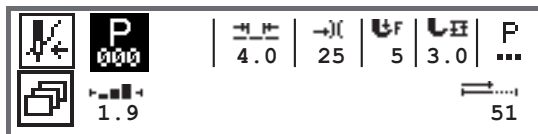

Fig. 36: Display in Manual mode



5.3 Software operating modes

The software of the 867-M PREMIUM has 3 available operating modes:

- **Manual mode (program 000)** (📖 p. 58)

Manual mode is the simplest operating mode. There are no programs/seam programs and no inputs for individual seam sections.

Changes to the sewing foot pressure, stroke height, stitch length, needle thread tension and, also, the activation of other functions are always implemented immediately.

All the major sewing parameters can be changed manually during the sewing process.

- **Automatic mode (program 001 – 999)** (📖 p. 87)

Automatic mode allows for the execution of setups (seam program comprised of only one seam section) or complex seam programs (comprising 2 or more seam sections).

Seam programs are divided into individual seam sections. Each section is assigned its own individual stitch length, needle thread tension, etc.

- **Programming/Edit mode** (📖 p. 91)

Programming mode allows the operator to create a new seam program in a quick and easy manner.

Edit mode can be used to adjust, delete and copy seam programs.

The individual modes and their uses are explained in detail later on.



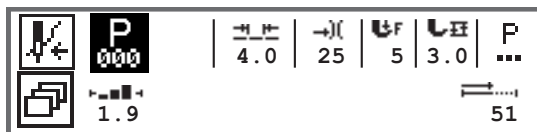

5.4 Using Manual mode





Fig. 37: Parameters in manual mode











The following table shows the individual symbols of parameters on the display and the functions of the buttons on the control panel. For some parameters, the exact setting is described in more detail later in the chapter.

The selected parameter is shown inverted on the control panel display. When a parameter is changed, its new value is loaded immediately.

Symbol	Meaning
	The button can be assigned various functions as required, p. 60 . <ul style="list-style-type: none"> Press softkey button
	Quick access function (softkey menu) Press the softkey menu button, p. 60 .
	Program number Value range: 000 - 999 Program 000 indicates that the control is in "Manual mode". <ul style="list-style-type: none"> Use ◀/▶ to select the Program parameter Use ▲/▼ to change the program number or enter the program number using the numeric buttons 0 – 9 and confirm with the OK button
	Stitch length Value range: 00.0 – 12.0 [mm] (depending on the sewing equipment and subclass) <ul style="list-style-type: none"> Use ◀/▶ to select the Stitch length parameter Use ▲/▼ to change the stitch length

Symbol	Meaning
	<p>Needle thread tension Value range: 01 - 99</p> <ul style="list-style-type: none"> • Use ◀/▶ to select the Needle thread tension parameter • Use ▲/▼ to change the needle thread tension <p>Information</p> <p>If the values for the needle thread tension of the right and the left needle thread are not identical and changed jointly, the difference remains the same.</p> <p>2-needle machines</p> <ul style="list-style-type: none"> • Use ◀/▶ to select the Needle thread tension parameter • Press the OK button to open the submenu • Use ▲/▼ to select the right or the left needle thread • Press the OK button to confirm • Use ▲/▼ to change the needle thread tension • Press the OK button to confirm
	<p>Sewing foot pressure Value range: 01 - 20</p> <ul style="list-style-type: none"> • Use ◀/▶ to select the Sewing foot pressure parameter • Use ▲/▼ to change the sewing foot pressure
	<p>Sewing foot stroke Value range: 00.0 – 09.0 [mm] (0.5 mm increments)</p> <ul style="list-style-type: none"> • Use ◀/▶ to select the Stroke height parameter • Use ▲/▼ to change the stroke height
	<p>Other parameters</p> <ul style="list-style-type: none"> • Use the OK button to go to the list • Use ▲/▼ to select the parameter • Use the OK button to go to the parameter settings <p>More detailed description of parameters:</p> <ul style="list-style-type: none"> • Speed (<i>Max. Speed</i>) (📖 p. 64) • Thread cutter (<i>Thread Trim</i>) (📖 p. 64) • Thread clamp (<i>Thread Clamp</i>) (📖 p. 64) • Initial alignment stitch (<i>PointPos. °</i>) (📖 p. 65) • Start bartack (<i>Start Tack</i>) (📖 p. 65) • End bartack (<i>End Tack</i>) (📖 p. 68) • Sewing foot lift (<i>Foot</i>) (📖 p. 70) • Bobbin monitor (<i>Bobbin</i>) (📖 p. 70) • Information (<i>Info</i>) (📖 p. 73) • Edge stop (<i>Edge Guide</i>) (📖 p. 74) • Correcting effects of high speed (<i>Speed Corr.</i>) (📖 p. 74) • Material thickness detection (<i>Fabric Thickness</i>) (📖 p. 79) • Light barrier (<i>LightBarrier</i>) (📖 p. 85)

Symbol	Meaning
	S.p.m. or seam length in [mm] The active option, either s.p.m. or mm, can be set at the Technician level. The s.p.m. option is set at the factory. After the thread has been cut off, the display is retained. Measurement/counting restarts when sewing starts again.
	<ul style="list-style-type: none"> • Cancel the function • Exit the menu (changes remain saved) to return to the starting level
	<ul style="list-style-type: none"> • Confirm the settings • Activate the input
	Create a program,  p. 91.
	No function assigned
	No function assigned
	No function assigned

5.4.1 Selecting the quick access function (softkey menu)

Here, you have quick access to functions during the sewing process. You can also assign a function to the **softkey** button.



To select a quick access function:

1. Press the **softkey menu**  button.
2. The following display appears:

Fig. 38: Softkey menu



- To select a function: Press the numeric button under the desired function.

OR

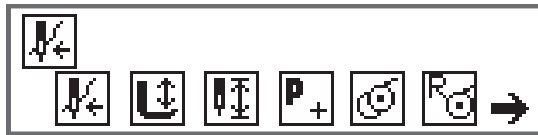
- To assign a function to the **softkey** button: Press the numeric button under the desired function and the **softkey** button at the same time.

↳ The function is assigned to the **softkey** button and can subsequently be called up using this softkey.











Information

There are various options available to assign to the **softkey** button depending on whether this is before the seam or in the seam.











- To exit the menu, press the **ESC** button or the **softkey menu** button.

Possible button assignment for the softkey button (Manual mode)

Symbol	Meaning
	Threading mode The needle bar moves to the defined position. The pedal is temporarily locked.
	Raise/lower sewing foot BEFORE the seam: Position of the sewing foot after thread cutting. IN the seam: Position of the sewing foot when sewing stops.

Symbol	Meaning
 A square icon containing a vertical needle with a horizontal line indicating its position, and a small square below it.	Needle position up / down If sewing is stopped within the seam, the needle is positioned up or down.
 BEFORE the seam A square icon containing a large letter 'P' and a plus sign '+'.	Programming Activation of programming mode.
 IN the seam A square icon containing a stylized thread cutter symbol.	Thread cutter Function active or inactive.
 BEFORE the seam A square icon containing a stylized bobbin symbol.	Bobbin mode
 IN the seam A square icon containing a vertical needle with a horizontal line indicating its position, and a small square below it.	Perform half stitches Half stitches are performed when the button is pressed (needle position raised or lowered).
 A square icon containing a stylized bobbin symbol and a circular arrow.	Resetting the bobbin stitch counter The defined maximum s.p.m. of the bobbin used is reset to the starting value.
 A square icon containing a stylized thread clamp symbol.	Thread clamp Function active or inactive.
 A square icon containing a vertical needle with a horizontal line indicating its position, and a plus sign '+'.	2 nd edge stop distance Moves the position for the 2 nd edge stop distance.
 A square icon containing a vertical needle with a horizontal line indicating its position, and a plus sign '+'.	Edge stop reference run If the edge stop has lost its correct position due to an interruption, the reference run returns it to its starting position.

**Possible button assignment for the softkey button
(Automatic mode)**

Symbol	Meaning
	Threading mode The needle bar moves to the defined position. The pedal is temporarily locked.
	Reset daily piece counter.
	Automatic stitch counting Function active or inactive.
 BEFORE the seam	Programming Activation of programming mode.
 BEFORE the seam	Bobbin mode
 IN the seam	Perform half stitches Half stitches are performed when the button is pressed (needle position raised or lowered).
	Resetting the bobbin stitch counter The defined maximum s.p.m. of the bobbin used is reset to the starting value.
	Thread clamp Function active or inactive.
	2 nd edge stop distance Moves the position for the 2 nd edge stop distance.
	Edge stop reference run If the edge stop has lost its correct position due to an interruption, the reference run returns it to its starting position.

5.4.2 Setting the Speed parameter (*Max. Speed*)



It is possible to reduce the maximum speed at this point. The value of the maximum speed can be set in the software at technician level.

Menu item	Setting option
(<i>Max. Speed</i>) Speed	0050 – 3800 [rpm] depending on subclass

5.4.3 Setting the Thread cutter parameter (*Thread Trim*)



Set whether the thread cutter is activated or deactivated at the end of the seam.

Menu item	Setting option
(<i>Thread Trim</i>) Thread cutter	ON = on OFF = off

5.4.4 Setting the Thread clamp parameter (*Thread Clamp*)



If a thread clamp is present, this function can be activated or deactivated here. The thread clamp is closed for the 1st stitch of the seam to ensure that the needle thread lies on the underside of the sewing material.

Menu item	Setting option
(<i>Thread Clamp</i>) Thread clamp	ON = on OFF = off

5.4.5 Setting the Initial alignment stitch parameter (*PointPos. °*)



The distance of the needle from the material can be adjusted to allow precise positioning of the sewing material when starting sewing. The value entered here corresponds to the degree number on the handwheel.



Menu item	Setting option
(<i>PointPos. °</i>) Initial alignment stitch function	000 – 359 [°]





5.4.6 Setting the Start bartack parameter (*Start Tack*)



There are various options for setting the start bartack. All subitems in the *Start Tack* menu are listed in the following table.

Settings that are more complex and therefore require further explanation are described in more detail after the table.

Menu items	Setting option 1	Setting option 2
<i>On</i>	ON/OFF	
<i>Stitches (↑)</i> Number of backward stitches	Value range 01 – 50	
<i>Stitches (↓)</i> Number of forward stitches	Value range 01 – 50	
<i>Repetitions,</i> Number of sections in a bartack  p. 67	Value range 01 – 10	
<i>t Change,</i> Waiting time at turning points  p. 67	Value range 0000 – 1000 [ms]	
<i>St. Len. Def.,</i> Default stitch length  p. 67	ON/OFF	

Menu items	Setting option 1	Setting option 2
	<i>St. Len.</i> (↑)	Value range 01.0 – 12.0 [mm] (depending on subclass)
	<i>St. Len.</i> (↓)	Value range 01.0 – 12.0 [mm] (depending on subclass)
<i>Speed</i> Speed in bartack	Value range 0000 – 2000	
<i>Pedal Stop</i> , Single stitches per pedal  p. 67	ON/OFF	
<i>Thr. Tens. Def.</i> , Default needle thread tension  p. 67	ON/OFF	Value range 01 - 99
<i>Catch Backtack</i> , Bartack before the bartack  p. 67	On	ON/OFF
	<i>Stitches</i> (↑)	Value range 01 - 50
	<i>Stitches</i> (↓)	Value range 01 - 50
<i>First Repet</i> , Number of stitches different for 1 st section  p. 67	On	ON/OFF
	<i>Stitches</i> (↑/↓)	Value range 01 - 50
<i>Invert Dir.</i> , Invert direction  p. 68	ON/OFF	

Setting: Number of sections in a bartack (*Repetitions*)

A bartack always consists of several sections. If the sewing direction is changed, a new section is started. The number of sections in a bartack can be set in this submenu.

Setting: Waiting time at turning point (*t Change*)

The waiting time at the turning points (for example for a change of sewing direction) is set at this point. A short waiting time in milliseconds should ensure consistent seam quality (ornamental-stitch bartack).

Setting: Default stitch length (*St. Len. Def.*)

If this function is active, the same stitch length is used for the bartack as the one set in Manual mode. If this function is deactivated, a custom input can be entered.

Setting: Single stitches per pedal (*Pedal Stop*)

If this function is activated, each stitch in the bartack can be sewn individually by pressing the pedal. This function can only be used meaningfully if the speed is set very low for the bartack.

Setting: Default needle thread tension (*Thr. Tens. Def.*)

If this function is active, the same needle thread tension is used for the bartack as the one set in Manual mode. If this function is deactivated, a custom input can be entered.

Setting: Bartack before the bartack (*Catch Backtack*)

To ensure a safe sewing start and complete sewing of the start bartack, an additional bartack can precede the start bartack.

Only the number of forward and backward stitches can be selected. The stitch length cannot be set individually – it corresponds to the stitch length of the normal start bartack.

Setting: Number of stitches different for 1st section

(First Repet.)

The 1st section of the bartack can be programmed with a different number of stitches. All subsequent sections have the preset number of stitches from the settings for the start bartack.



Setting: Invert direction (Invert Dir.)

Normally, a bartack starts either with the sewing direction (forwards – even number of sections) or against the sewing direction (backwards – odd number of sections), depending on the number of sections.

Setting this parameter inverts the sewing direction of the bartack.





5.4.7 Set End bartack parameter (End Tack)



There are various options for setting the end bartack. All subitems in the *End Tack* menu are listed in the following table.

Settings that are more complex and therefore require further explanation are described in more detail in the chapter on the start bartack (📖 p. 65) or below the table.

Menu items	Setting option 1	Setting option 2
<i>On</i>	ON/OFF	
<i>Stitches</i> (↑) Number of backward stitches	Value range 01 – 50	
<i>Stitches</i> (↓) Number of forward stitches	Value range 01 – 50	
<i>Repetitions</i> , Number of sections in a bartack 📖 p. 67	Value range 01 – 10	
<i>t Change</i> , Waiting time at turning points 📖 p. 67	Value range 0000 – 1000 [ms]	
<i>St.Len.Def.</i> , Default stitch length 📖 p. 67	ON/OFF	

Menu items	Setting option 1	Setting option 2
	<i>St. Len.</i> (↑)	Value range 01.0 – 12.0 [mm] (depending on subclass)
	<i>St. Len.</i> (↓)	Value range 01.0 – 12.0 [mm] (depending on subclass)
<i>Speed</i> Speed in bartack	Value range 0000 – 2000	
<i>Pedal Stop</i> , Single stitches per pedal  p. 67	ON/OFF	
<i>Thr. Tens. Def.</i> , Default needle thread tension  p. 67	ON/OFF	Value range 01 - 99
<i>Catch Backtack</i> , Bartack after the bartack  p. 67	On	ON/OFF
	<i>Stitches</i> (↑)	Value range 01 - 50
	<i>Stitches</i> (↓)	Value range 01 - 50
<i>Last Repet</i> , Number of stitches different for last section  p. 69	On	ON/OFF
	<i>Stitches</i> (↑/↓)	Value range 01 - 50
<i>Invert Dir.</i> , Invert direction  p. 68	ON/OFF	

Setting: Number of stitches different for last section

(Last Repet.)

The last section of the bartack can be programmed with a different number of stitches. All previous sections have the preset number of stitches from the settings for the end bartack.

This function is useful for the short stitch for the short thread cutter, for example. In this case, one less stitch is sewn in the last section.

5.4.8 Setting the Sewing foot lift parameter (Foot)



The sewing foot lift can have various settings. Possible settings and the corresponding value ranges are listed in the table.

Menu item	Setting option
<i>FL AtStop</i> , Sewing foot lift when sewing stops	ON = on OFF = off
<i>FL AfterTrim</i> , Sewing foot lift after thread cutting	ON = on OFF = off
<i>FL ht.AtStop</i> , High sewing foot lift when sewing stops	Value range 00 – 20 [mm] (depending on subclass)
<i>FL ht.A.Trim</i> , High sewing foot lift after thread cutting	Value range 00 – 20 [mm] (depending on subclass)

5.4.9 Setting the Bobbin monitor parameter (Bobbin)





The amount of remaining thread on the bobbin can be monitored optically or by software using this setting.



Information

The bobbin monitor setting is global and NOT limited to an operating mode or a seam program.

Settings that are more complex and therefore require further explanation are described in more detail after the table.

Menu items	Setting option 1	Setting option 2
<i>Off</i>		
<i>Monitor</i> ,  <i>p. 71</i>	<i>t Clean</i>	Value range 0000 – 5000 [ms]
	<i>Motor Stop</i>	ON/OFF
<i>Softw.</i> , Software  <i>p. 72</i>	<i>CounterType</i>	A/B/C/D
	<i>Counter</i>	Value range 00000 – 99999
	<i>MotorStop</i>	ON/OFF
	<i>ResetNeces</i>	ON/OFF



Setting: Monitor (*Monitor*)

Monitor mode can only be used if the additional equipment of the remaining thread monitor is present on the machine. Monitor mode allows for optical monitoring of the bobbin. The possible settings are listed in the table.

<i>t Clean</i> Value range 0000 – 5000 [ms]	Duration for which the lens is blown clear with compressed air. The process takes place as the thread is cut.
<i>Motor Stop</i> ON/OFF	Sewing stops and a notice is shown on the display when the bobbin is detected to be nearly empty. If the parameter is not activated, only the LEDs on the machine arm give a warning if the bobbin is empty.

Setting: Software (Softw.)

In Software mode, the bobbin is monitored by the software based on the number of stitches sewn. The possible settings are listed in the table.

<i>CounterType</i> A/B/C/D	4 different counters can be applied. The following 3 subitems can be set for each of the counters.
<i>Counter</i> Value range 00000 – 99999	Bobbin supply capacity in stitches. This is a very variable value, which depends on the size of the bobbin and the thickness of the thread.
<i>MotorStop</i> ON/OFF	Sewing stops and a notice is shown on the display when the bobbin is detected to be nearly empty. If the parameter is not activated, only the LEDs on the machine arm give a warning if the bobbin is empty.
<i>ResetNeces</i> ON/OFF	It is only possible to resume sewing after changing the bobbin and confirming the message on the control panel.

5.4.10 Setting the Information parameter (*Info*)

Information can be displayed on certain settings during sewing as desired or required.

Fig. 39: Display with information shown

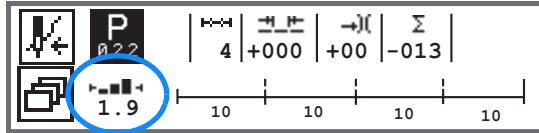

Possible settings for the Information parameter

Symbol	Menu item	Meaning
	<i>Off</i>	no display
	<i>Pedal</i>	Pedal position (Value range 24 – -2)
	<i>Thick</i>	Material thickness detection
	<i>Pos</i>	Handwheel position (Value range 000 – 359 [°])
	<i>Speed</i>	Current speed
	<i>Bobbin</i>	Bobbin stitch counter

5.4.11 Setting the Edge stop parameter (*Edge Guide*)



The edge stop helps to precisely position the sewing material. The value set indicates the distance between the needle and edge stop/material edge.

The 2nd distance for the edge stop can only be accessed using the **softkey menu** button or the **softkey** button if these are assigned to the 2nd distance.

Menu item	Setting option
Gap Edge stop	Value range 01.0 – 45.0 [mm]
Gap (+) Edge stop 2 nd Distance	Value range 01.0 – 45.0 [mm]



5.4.12 Setting the Correction of effects of high speed parameter (*Speed Corr.*)



Some parameters are affected by high speeds because of the resulting physical effects. To counteract these effects and to achieve consistent results, even at high speeds, adjustment factors can be set depending on the speed.

Settings that are more complex and therefore require further explanation are described in more detail after the table.

Menu items	Setting option 1	Setting option 2
ON/OFF		
Stitchlen., Stitch length p. 77	Off	
	linear	Stitchlen.
		Min. speed
		Max. speed
	2.OnOff	Min. speed
	2.On	Min. speed

Menu items	Setting option 1	Setting option 2
<i>Thr. Tens.</i> , Needle thread tension  p. 78	<i>Off</i>	
	<i>linear</i>	<i>Thr. Tens.</i>
		<i>Min. speed</i>
		<i>Max. speed</i>
	<i>2.OnOff</i>	<i>Min. speed</i>
	<i>2.On</i>	<i>Min. speed</i>
<i>FootPress.</i> , Sewing foot pressure  p. 78	<i>Off</i>	
	<i>linear</i>	<i>FootPress.</i>
		<i>Min. speed</i>
		<i>Max. speed</i>

Overview of settings modes

The correction of the effects of high speeds can be identified in various modes and responded to depending on the setting. This general explanation can be applied to the following specific parameters.

Setting mode	Description
<i>linear</i>	In the linear setting, the size of the parameter increases or decreases steadily as the speed increases. The increase/decrease of the parameter depends on the limits set for the minimum and maximum speed.
<i>2. OnOff</i>	If a certain speed is exceeded, the 2 nd value of the parameter is activated. If the speed then falls below this level again, it switches to the base value for the parameter.
<i>2. On</i>	If a certain speed is exceeded, the 2 nd value of the parameter is activated. If the speed then falls below this level again, it DOES NOT switch to the base value for the parameter. Only after finishing the seam by cutting the thread is the base value for the parameter set again.



Setting: Stitch length (*Stitchlen.*)

The stitch length changes slightly depending on the speed. For this reason, the stitch length can be adjusted at different speeds by the software.

<i>linear</i>	<i>Stitchlen.</i> Value range -50 – 50 [%]	Maximum stitch length variation reached at the upper speed limit.
	<i>Min. speed</i> Value range 0000 – 4000 [rpm] (depending on subclass)	Speed at which the increase/reduction of stitch length should start.
	<i>Max. speed</i> Value range 0000 – 4000 [rpm] (depending on subclass)	Speed up to which the increase/reduction of stitch length should occur.
<i>2.OnOff</i>	<i>Min. speed</i> Value range 0000 – 4000 [rpm] (depending on subclass)	Speed from which the 2 nd stitch length should be used.
<i>2.On</i>	<i>Min. speed</i> Value range 0000 – 4000 [rpm] (depending on subclass)	Speed from which the 2 nd stitch length should be used.

Setting: Needle thread tension (*Thr. Tens.*)

Depending on the speed, the needle thread tension can be adjusted at different speeds by the software.

<i>linear</i>	<i>Thr. Tens.</i> Value range 00 – 99	Maximum needle thread tension reached at the upper speed limit.
	<i>Min. speed</i> Value range 0000 – 4000 [rpm] (depending on subclass)	Speed at which the increase in needle thread tension should start.
	<i>Max. speed</i> Value range 0000 – 4000 [rpm] (depending on subclass)	Speed up to which the increase in needle thread tension should occur.
<i>2.OnOff</i>	<i>Min. speed</i> Value range 0000 – 4000 [rpm] (depending on subclass)	Speed from which the 2 nd needle thread tension should be used.
<i>2.On</i>	<i>Min. speed</i> Value range 0000 – 4000 [rpm] (depending on subclass)	Speed from which the 2 nd needle thread tension should be used.

Setting: Sewing foot pressure (*FootPress.*)

Depending on the speed, the sewing foot pressure can be adjusted at different speeds by the software.

<i>linear</i>	<i>FootPress</i> Value range 00 – 20	Maximum sewing foot pressure reached at the upper speed limit.
	<i>Min. speed</i> Value range 0000 – 4000 [rpm] (depending on subclass)	Speed at which the increase in sewing foot pressure should start.
	<i>Max. speed</i> Value range 0000 – 4000 [rpm] (depending on subclass)	Speed up to which the increase in sewing foot pressure should occur.

5.4.13 Setting the Material thickness detection parameter (*Fabric Thickness*)



To achieve consistently good sewing results for different material thicknesses, some parameters can be adjusted specifically to the material thickness.

Settings that are more complex and therefore require further explanation are described in more detail after the table.

Menu items	Setting option 1	Setting option 2
ON/OFF		
<i>Stroke</i> , Sewing foot stroke 📖 p. 82	<i>Off</i>	
	<i>linear</i>	<i>Stroke</i>
		<i>ThickMin</i>
		<i>ThickMax</i>
	<i>2.OnOff</i>	<i>ThickMin</i>
	<i>2.On</i>	<i>ThickMin</i>
<i>Stitchlen.</i> , Stitch length 📖 p. 83	<i>Off</i>	
	<i>linear</i>	<i>Stitchlen.</i>
		<i>ThickMin</i>
		<i>ThickMax</i>
	<i>2.OnOff</i>	<i>ThickMin</i>
	<i>2.On</i>	<i>ThickMin</i>
<i>Thr.Tens.</i> , Needle thread tension 📖 p. 84	<i>Off</i>	
	<i>linear</i>	<i>Thr.Tens.</i>
		<i>ThickMin</i>
		<i>ThickMax</i>

Menu items	Setting option 1	Setting option 2
	<i>2.OnOff</i>	<i>ThickMin</i>
	<i>2.On</i>	<i>ThickMin</i>
<i>FootPress., Sewing foot pressure 📖 p. 84</i>	<i>Off</i>	
	<i>linear</i>	<i>FootPress.</i>
		<i>ThickMin</i>
		<i>ThickMax</i>
<i>Max. Speed, Speed 📖 p. 84</i>	<i>Off</i>	
	<i>linear</i>	<i>Max.Speed</i>
		<i>ThickMin</i>
		<i>ThickMax</i>

Overview of settings modes

The material thickness can be identified in various modes and responded to depending on the setting. This general explanation can be applied to the following specific parameters.

Setting mode	Description
<i>linear</i>	In the linear setting, the size of the parameter increases or decreases steadily as the material thickness increases. The increase/decrease in the parameter depends on the limits set for the minimum and maximum material thickness.
<i>2. OnOff</i>	If a certain material thickness is exceeded, the 2 nd value of the parameter is activated. If the material thickness then falls below this level again, it switches to the base value for the parameter.
<i>2. On</i>	If a certain material thickness is exceeded, the 2 nd value of the parameter is activated. If the material thickness then falls below this level again, it DOES NOT switch to the base value for the parameter. Only after finishing the seam by cutting the thread is the base value for the parameter set again.

Setting: Sewing foot stroke (*Stroke*)

The sewing foot stroke can be adjusted at different material thicknesses by the software.

<i>linear</i>	<i>Stroke</i> Value range 00 – 09 [mm]	Maximum sewing foot stroke reached at the upper material thickness limit.
	<i>ThickMin</i> Value range 00.0 – 10.0 [mm]	Material thickness at which the increase in sewing foot stroke should start.
	<i>ThickMax</i> Value range 00.0 – 10.0 [mm]	Material thickness up to which the increase in sewing foot stroke should occur.
<i>2 . OnOff</i>	<i>ThickMin</i> Value range 00.0 – 10.0 [mm]	Material thickness from which the 2 nd sewing foot stroke height should be used.
<i>2 . On</i>	<i>ThickMin</i> Value range 00.0 – 10.0 [mm]	Material thickness from which the 2 nd sewing foot stroke height should be used.



Setting: Stitch length (*Stitchlen.*)

The stitch length changes slightly depending on the material thickness. For this reason, the stitch length can be adjusted at different material thicknesses by the software.

<i>linear</i>	<i>Stitchlen.</i> Value range -50 – 50 [%]	Maximum stitch length variation reached at the upper material thickness limit.
	<i>ThickMin</i> Value range 00.0 – 10.0 [mm]	Material thickness at which the increase/reduction of stitch length should start.
	<i>ThickMax</i> Value range 00.0 – 10.0 [mm]	Material thickness up to which the increase/reduction of stitch length should occur.
<i>2. OnOff</i>	<i>ThickMin</i> Value range 00.0 – 10.0 [mm]	Material thickness from which the 2 nd stitch length should be used.
<i>2. On</i>	<i>ThickMin</i> Value range 00.0 – 10.0 [mm]	Material thickness from which the 2 nd stitch length should be used.

Setting: Needle thread tension (*Thr. Tens.*)

Depending on the material thickness, the needle thread tension can be adjusted at different material thicknesses by the software.

<i>linear</i>	<i>Thr. Tens.</i> Value range 00 – 99	Maximum needle thread tension reached at the upper material thickness limit.
	<i>ThickMin</i> Value range 00.0 – 10.0 [mm]	Material thickness at which the increase in needle thread tension should start.
	<i>ThickMax</i> Value range 00.0 – 10.0 [mm]	Material thickness up to which the increase in needle thread tension should occur.
<i>2. OnOff</i>	<i>ThickMin</i> Value range 00.0 – 10.0 [mm]	Material thickness from which the 2 nd needle thread tension should be used.
<i>2. On</i>	<i>ThickMin</i> Value range 00.0 – 10.0 [mm]	Material thickness from which the 2 nd needle thread tension should be used.

Setting: Sewing foot pressure (*FootPress*)

The sewing foot pressure can be adjusted at different material thicknesses by the software.

<i>linear</i>	<i>FootPress</i> Value range 00 – 20	Maximum sewing foot pressure reached at the upper material thickness limit.
	<i>ThickMin</i> Value range 00.0 – 10.0 [mm]	Material thickness at which the increase in sewing foot pressure should start.
	<i>ThickMax</i> Value range 00.0 – 10.0 [mm]	Material thickness up to which the increase in sewing foot pressure should occur.

5.4.14 Setting the light barrier (*LightBarrier*) parameter



The light barrier detects the beginning and the end of the material. After a signal was detected, sewing can continue automatically with the specifically set parameters.

Menu item	Setting option
<i>LightBarrier</i> , Light barrier	ON = on OFF = off
<i>Start</i> , Signal detection at the beginning of the material	ON/OFF
<i>End</i> , Signal detection at the end of the material	ON/OFF
<i>Distance</i> , Distance from signal detection to end of material	Value range 0 – 255
<i>Seams</i> , Number of signal detections	Value range 1 – 255
<i>Filter</i> , Filter stitches up to signal detection	Value range 0 – 255



Setting: Signal detection at the beginning of the material (*Start*)

The signal scan of the light barrier is performed at the beginning of the seam. If the function is activated, the light barrier must detect a signal to allow the machine to sew. If the function is inactive, sewing can take place without signal detection.



Setting: Signal detection at the end of the material (*End*)

The signal scan of the light barrier is performed at the end of the seam. If the function is active, the machine will continue to sew with the specifically set parameters following the signal detection. If the function is inactive, nothing will happen.



Setting: Distance from signal detection to end of material
(*Distance*)

Here, you can set the distance from the detection of the signal to the end of the material. This distance signifies the path from the needle to the light barrier. The path is specified in millimeters and used by the machine to independently calculate the number of stitches.



Setting: Number of signal detections (*Seams*)

Input of the number of signal detections after which the machine is supposed to continue with the specifically set parameters.



Setting: Filter stitches up to signal detection (*Filter*)

Loosely woven fabric with stitches may cause the light barrier to wrongly detect a signal. To prevent this from happening, you enter the number of filter stitches. This number represents the minimum number of stitches with signal detection following the 1st detection of the signal.

5.5 Using Automatic mode

Automatic mode includes all program numbers from 001 to 999.



To access Automatic mode:





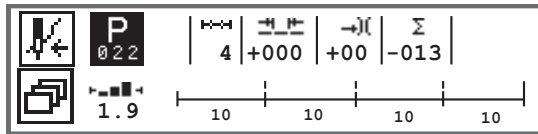

1. Use ◀/▶ to select the **Program** parameter.
 2. Use ▲/▼ to select the program number **001** or another one (if available).
- ↳ The software switches to Automatic mode, the program name is shown briefly, and then the following display appears:

Fig. 40: Display in Automatic mode



The following table explains the individual symbols on the display and the functions of the buttons on the control panel.

Symbol	Description
	Depending on the assignment of buttons, there may be different functions here, p. 60 . • Press softkey button
	Quick access function (softkey menu) Press the softkey menu button, p. 60 .
P	Program number Value range: 000 - 999 • Use ◀/▶ to select the Program parameter • Use ▲/▼ to change the program number or enter the program number using the numeric buttons 0 – 9 and confirm with the OK button If you select program 000, the control selects Manual mode, p. 58 .
	Seam sections Number of seam sections contained in the current program.

Symbol	Description
	Stitch length correction factor Value range: -50 – 50 [%] Alters the stitch length in all seam sections with ▲/▼.
	Default needle thread tension adjustment factor Value range: -50 – 50 [%] Alters the needle thread tension in all seam sections with ▲/▼.
	Day piece counter Function active or inactive,  p. 98.
	Information on the display Can be assigned differently as desired,  p. 73.

5.5.1 Sewing in Automatic mode

After selecting a program between 001 and 999, you will be in Automatic mode.



To sew in Automatic mode:

1. Press the pedal forward and sew.
-  The following display appears:

Fig. 41: Display when sewing in Automatic mode



The parameter values for the current seam section are shown on the display.

The program bar shows the progress of the seam program. The number under the current seam section shows the number of stitches yet to be sewn / the outstanding length of the seam section.

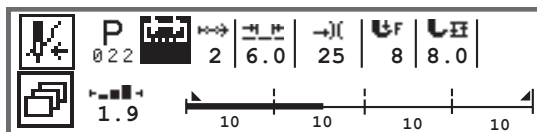
The program bar shows half the current seam section in bold.

Fig. 42: Seam section in progress

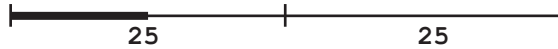







Completed seam sections are shown fully in bold.

Fig. 43: Completed seam section





Additional information is shown next to the program bar, which can be identified at a glance thanks to the small symbols on the display:

Symbol	Meaning
	Start bartack
	End bartack
	Manually switch between two seam sections (using ◀/▶ or button assignment for the push button on the machine arm or knee button); there is no stitch counting
"10"	Number of stitches or length in mm of the seam section. The active option, either s.p.m. or mm, can be set at the Technician level. The s.p.m. option is set at the factory.
	Stop at the end of the seam section with thread cutting
	Switch between two seam sections without stopping
	Switch between two seam sections, with a stop, but without thread cutting

Possible actions in the course of the seam



The following table lists the functions that can be performed in the course of the seam.

Button/Pedal	Function
	Seam section forwards/backwards or go to start of seam section.
Pedal halfway back	Lift sewing foot.
Pedal fully back	Cut off or cancel the program. The program remains stopped at the cutoff point.
	Softkey menu,  p. 60.

5.5.2 Canceling a program in automatic mode



To cancel a program in automatic mode:

1. Push the pedal fully back.
 -  The program is canceled and the thread cut. The machine takes note of where the program was canceled, and then continues from the same point when sewing resumes.
2. To cancel the program completely, press the pedal all the way backwards again.
 -  The program is canceled, and the machine starts from the first seam section in the program when sewing resumes.

5.6 Using Programming/Edit mode

5.6.1 Creating a new program



To create a new program:



1. Press the  button.
 - ↳ The softkey menu appears.
2. Press the  button.
 - ↳ The control displays the next free program number.

Fig. 44: Creating a new program



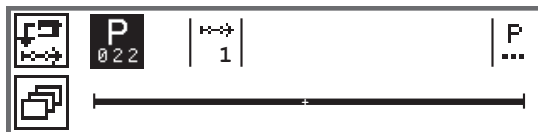

3. Press the **OK** button to load the program number.
 - Or:
4. Choose a different program number using **▲/▼** or enter one with the numeric buttons **0 – 9** and then press the **OK** button (only free program positions are shown/accepted as numeric entries).
 - ↳ The following information is shown, and the P in the program number field flashes:

Fig. 45: Programming mode display



Programming mode offers two options for creating new seam programs:

- Creating a program using keyboard input,  p. 92.
- Creating a program using teach-in,  p. 94.

5.6.2 Creating a program using keyboard input

Creating a program using keyboard input is done completely without sewing. All parameters for the seam sections and the program are entered manually.



To create a program using keyboard input:

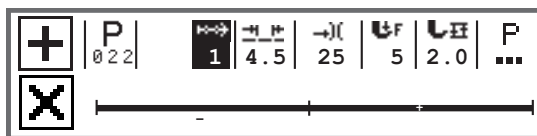

1. Create a new program, p. 91.
2. Use **▶** to switch to the seam section selection.
3. Use to activate the seam section.
 - ↳ The following display is shown, with preset values which can be specified at technician level.

Fig. 46: Programming mode display





4. Set the basic parameters that are explained in the table.

Symbol	Meaning
	Stitch length for the current seam section Value range: 00.0 – 12.0 [mm] (depending on subclass) <ul style="list-style-type: none"> • Use ◀/▶ to select the Stitch length parameter • Use ▲/▼ to change the stitch length

Symbol	Meaning
	<p>Needle thread tension value (%) of current seam section Value range: 00 - 99</p> <ul style="list-style-type: none"> • Use ◀/▶ to select the Needle thread tension parameter • Use ▲/▼ to change the needle thread tension. <p>Information</p> <p>If the values for the needle thread tension of the right and the left needle thread are not identical and changed jointly, the difference remains the same.</p> <p>2-needle machines</p> <ul style="list-style-type: none"> • Use ◀/▶ to select the Needle thread tension parameter • Press the OK button to open the submenu • Use ▲/▼ to select the right or the left needle thread • Press the OK button to confirm • Use ▲/▼ to change the needle thread tension • Press the OK button to confirm
	<p>Sewing foot pressure Value range: 01 - 20</p> <ul style="list-style-type: none"> • Use ◀/▶ to select the Sewing foot pressure parameter. • Use ▲/▼ to change the sewing foot pressure
	<p>Stroke height Value range: 00.0 – 09.0 [mm] (0.5 mm increments)</p> <ul style="list-style-type: none"> • Use ◀/▶ to select the Stroke height parameter • Use ▲/▼ to change the stroke height



5. Set other parameters for this seam section,  p. 96.
 6. To set up another seam section, use ▲ on the seam section display to switch to the next seam section.
 7. Use  to activate the seam section and set parameters again as described above.
 8. Repeat steps 6 and 7 to define up to 30 seam sections if necessary.
 9. Press the **ESC** button.
-  The program is saved. The machine switches to Automatic mode and the newly created program is selected.

5.6.3 Creating a program using Teach-In

Creating a program using Teach-In is done by sewing the seam sections and manually entering the parameters for the seam sections and the program.



To create a program using Teach-In:







1. Create a new program,  p. 91.
 2. Press the **Teach-In**  button.
- ↳ The following display is shown, with preset values which can be specified at technician level.

Fig. 47: Programming mode display

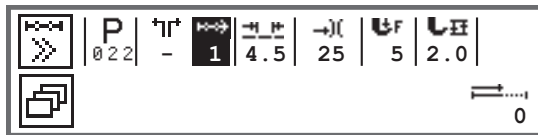

3. Set the basic parameters that are explained in the table.

Symbol	Meaning
	Stitch length for the current seam section Value range: 00.0 – 12.0 [mm] (depending on subclass) <ul style="list-style-type: none"> • Use ◀/▶ to select the Stitch length parameter • Use ▲/▼ to change the stitch length

Symbol	Meaning
	<p>Needle thread tension value (%) of current seam section Value range: 00 - 99</p> <ul style="list-style-type: none"> • Use ◀/▶ to select the Needle thread tension parameter • Use ▲/▼ to change the needle thread tension. <p>Information If the values for the needle thread tension of the right and the left needle thread are not identical and changed jointly, the difference remains the same.</p> <p>2-needle machines</p> <ul style="list-style-type: none"> • Use ◀/▶ to select the Needle thread tension parameter • Press the OK button to open the submenu • Use ▲/▼ to select the right or the left needle thread • Press the OK button to confirm • Use ▲/▼ to change the needle thread tension • Press the OK button to confirm
	<p>Sewing foot pressure Value range: 01 - 20</p> <ul style="list-style-type: none"> • Use ◀/▶ to select the Sewing foot pressure parameter. • Use ▲/▼ to change the sewing foot pressure
	<p>Stroke height Value range: 00.0 – 09.0 [mm] (0.5 mm increments)</p> <ul style="list-style-type: none"> • Use ◀/▶ to select the Stroke height parameter • Use ▲/▼ to change the stroke height



4. Press the pedal and complete the seam section up to the desired position on the material.





5. To set other parameters for another seam section, use ▲ to add a new seam section.

6. Set the basic parameters.

7. Repeat steps 5 and 6 to define up to 30 steps if necessary.

8. Push the pedal fully back.

 The program switches to Edit mode.

9. If necessary, set additional parameters for all seam sections ( p. 96) and complete the selected program ( p. 98).

10. Press the **ESC** button.

↳ The program is saved. The machine switches to Automatic mode and the newly created program is selected.

5.6.4 Adjusting parameters for the current seam section





This menu allows the parameters for the current seam section to be changed. This setting **ONLY** affects the currently selected seam section, and **NOT** the entire program.

















To adjust the parameters for the current seam section:

1. Use ◀/▶ to select the field .
2. Press the **OK** button.
- ↳ The submenu opens.
3. Use ▲/▼ to select the desired parameter.
4. Press the **OK** button to activate or deactivate the parameter or use ▲/▼ to edit the value and confirm the change by pressing the **OK** button.

Parameters for the current seam section:

Symbol	Description
	<i>StitchCount</i> Length of the seam section 0 = Manually step through > 1 = Number of stitches or length in mm
	<i>Max. speed</i> Maximum speed for the seam section.

Symbol	Description
	<p><i>Seg. End Modes</i> Set what happens at the end of a seam section when switching to the next section:</p> <ul style="list-style-type: none"> • <i>Stop</i> Sewing stops – if OFF: no more settings possible, smooth switch between the seams sections if ON: • <i>Thread Trim</i> – Thread cutting • <i>Needle Up</i> – Needle position • <i>Foot Lifted</i> – Sewing foot lift • <i>FL height</i> – Sewing foot lift stroke height
	<p><i>Start Tack</i> Start bartack, setting identical to Manual mode,  p. 65.</p>
	<p><i>End Tack</i> End bartack, setting identical to Manual mode,  p. 68.</p>
	<p><i>Needle Up</i> Position of the needle when sewing stops on the seam section.</p>
	<p><i>Foot lifted</i> Position of the sewing foot when sewing stops on the seam section.</p>
	<p><i>FL height</i> Lifting height of the sewing foot when sewing stops on the seam section.</p>
	<p><i>Backwards</i> Backward stitches; when the parameter is activated, the section is sewn backwards.</p>
	<p><i>Center Guide</i> Seam middle guide (only on 2-needle machines)</p>
	<p><i>Edge Guide</i></p> <ul style="list-style-type: none"> • <i>Gap</i> Edge stop (if available); value for the distance between the needle and the material edge, setting identical to Manual mode,  p. 74.

Symbol	Description
	<i>LightBarrier</i> Detects the beginning or the end of the material, setting identical to Manual mode,  p. 85.



5. Exit the submenu using the **ESC** or **◀** button
 - ↳ The changed values are stored immediately.
6. If necessary, create further seam sections or exit Programming mode using the **ESC** button.
 - ↳ The program is saved. The machine switches to Automatic mode and the newly created program is selected.

5.6.5 Adjusting parameters for the selected program

P
001-999









This menu allows the parameters for the current program/seam program to be changed. This setting affects all seam sections created in the program.









To adjust the parameters for the selected program:

1. Use **◀/▶** to select the field ^P **...**.
2. Press the **OK** button.
 - ↳ The submenu opens.
3. Use **▲/▼** to select the desired parameter.
4. Press the **OK** button to activate or deactivate the parameter or use **▲/▼** to edit the value and confirm the change by pressing the **OK** button.

Parameters for selected program:

Symbol	Description
 001-999	<i>Prog. Name</i> A program name can be entered using the numeric buttons: <ul style="list-style-type: none"> • Use ◀/▶ to navigate forwards and backwards • Use the F button to delete a letter • Use the OK button to confirm the entry • Use the ESC button to discard the entry
	<i>Add Values (+)</i> <ul style="list-style-type: none"> • <i>St. Len. (+)</i> • <i>F. Stroke (+)</i> • <i>Thr. Tens. (+)</i> • <i>Gap (+)</i> 2 nd value of the parameters
 001-999	<i>Next Prog.</i> A subsequent program can be defined.
	<i>Thread Clamp</i> Function active or inactive, if available.
	<i>Bobbin</i> Setting identical to Manual mode,  p. 70.
	<i>Info</i> Setting identical to Manual mode,  p. 73.
	<i>DailyPieces</i> Daily piece counter, can be set to count either up or down. When the daily piece counter is activated, it must be reset once after entering a value using the function in the softkey menu to ensure it counts correctly.

Symbol	Description
	<i>PointPos. °</i> Setting identical to Manual mode,  p. 65.
	<i>Speed Corr</i> Setting identical to Manual mode,  p. 74.
	<i>FabricThickness</i> If present, setting identical to Manual mode,  p. 79.



5. Exit the submenu using the **ESC** or **◀** button.

↳ The changed values are stored immediately.

6. If necessary, create further seam sections or exit Programming mode using the **ESC** button.

↳ The program is saved. The machine switches to Automatic mode and the newly created program is selected.

5.6.6 Editing programs

Parameters of already created programs can be adjusted subsequently.



To edit a program:

1. Select the desired program.







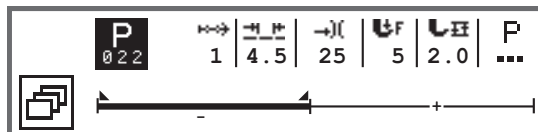

2. Press the **P** button.

↳ The control switches to Edit mode.

The following information is shown, and the P in the program number field flashes:

Fig. 48: Display in editing mode



- 
 3. Select the seam section to be changed using  with /.
 - ↳ The selected seam section is shown in bold in the program bar.
- 4. Adjust the basic parameters.
- 5. Adjust the parameters for the selected seam section,  p. 96.
- 6. Adjust the parameters for the entire program,  p. 98.
- 7. Use  to add a new seam section.
- 8. Use  to delete the seam section marked in bold in the program bar.
- 9. Exit Edit mode using the **ESC** button.
 - ↳ The program is saved. The machine switches to Automatic mode and the newly created program is selected.

5.6.7 Copying the program

Only the selected program is copied to a new program number.

 To copy a program:

- 1. Select the desired program.
- 2. Press the **P** button.
 - ↳ The P above the program number will flash.
- 3. Press the **softkey menu**  button.
 - ↳ The softkey menu appears.

Fig. 49: Softkey menu



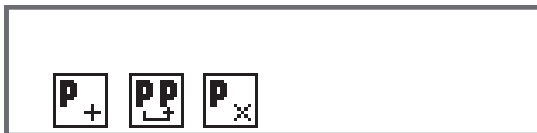

- 
 4. Press the numeric button under .
 - ↳ The following display appears:

Fig. 50: Copying the program



↪ The control displays the next free program number.



5. Press the **OK** button to load the program number.

OR

Select another program number using ▲/▼ or input a program number using the numeric buttons **0 – 9**.

6. Press the **OK** button to confirm the program number.

↪ The program number is loaded.

The control switches to Edit mode and the program number flashes:

Fig. 51: Display after specifying the program number

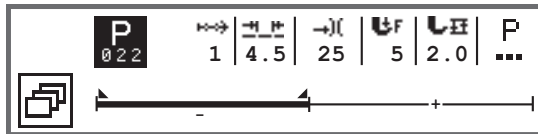

7. If necessary, make changes to the newly copied program.

8. Press the **ESC** button.

↪ The program is saved. The machine switches to Automatic mode and the newly created program is selected.

5.6.8 Deleting the program

Only the selected program can be deleted.



To delete a program:



1. Select the desired program.
2. Press the **P** button.
 - ↳ The P above the program number will flash.
3. Press the **softkey menu**  button.
 - ↳ The softkey menu appears.

Fig. 52: Softkey menu



4. Press the numeric button under .
 - ↳ The selected program is deleted. The program below/above is selected and can be edited.
5. To delete further programs, select the program using ▲/▼ and repeat from step 3.
6. Press the **ESC** button to go to Automatic mode.
 - ↳ The machine switches to Automatic mode.

6 Maintenance

WARNING



Risk of injury from sharp parts!

Punctures and cutting possible.

Prior to any maintenance work, switch off the machine or set the machine to threading mode.

WARNING



Risk of injury from moving parts!

Crushing possible.

Prior to any maintenance work, switch off the machine or set the machine to threading mode.

This chapter describes maintenance work that needs to be carried out on a regular basis to extend the service life of the machine and achieve the desired seam quality.

Advanced maintenance work may only be carried out by qualified specialists ( *Service Instructions*).

Maintenance interval

Work to be carried out	Operating hours			
	8	40	160	500
Cleaning				
Removing lint and thread remnants	●			
Lubricating				
Lubricating the machine head	●			
Lubricating the hook		●		

Work to be carried out	Operating hours			
	8	40	160	500
Servicing the pneumatic system				
Setting the operating pressure	●			
Draining the water condensation	●			
Cleaning the filter element		●		

6.1 Cleaning

WARNING



Risk of injury from flying particles!

Flying particles can enter the eyes, causing injury.

Wear safety goggles.

Hold the compressed air gun so that the particles do not fly close to people.

Make sure no particles fly into the oil pan.

NOTICE

Property damage from soiling!

Lint and thread remnants can impair the operation of the machine.

Clean the machine as described.

NOTICE
Property damage from solvent-based cleaners!

Solvent-based cleaners will damage paintwork.

Use only solvent-free substances for cleaning.

Fig. 53: Areas requiring special cleaning

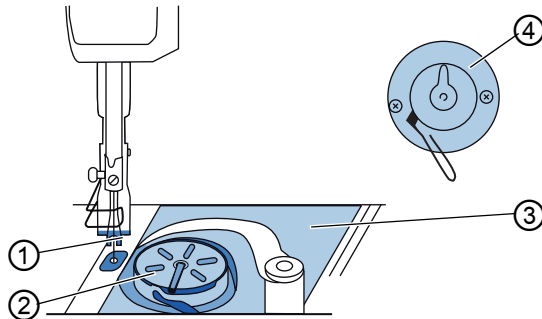

(1) - Area around the needle

(2) - Hook

(3) - Area under the throat plate

(4) - Cutter on the winder

Areas particularly susceptible to soiling:

- Cutter on the winder for the hook thread (4)
- Area under the throat plate (3)
- Hook (2)
- Area around the needle (1)

Cleaning steps:

1. Switch off the machine at the main switch.
2. Remove any lint and thread remnants using a compressed air gun or a brush.

6.2 Lubricating

CAUTION



Risk of injury from contact with oil!

Oil can cause a rash if it comes into contact with skin.

Avoid skin contact with oil.

If oil has come into contact with your skin, wash the affected areas thoroughly.

NOTICE

Property damage from incorrect oil!

Incorrect oil types can result in damage to the machine.

Only use oil that complies with the data in the instructions.

CAUTION



Risk of environmental damage from oil!

Oil is a pollutant and must not enter the sewage system or the soil.

Carefully collect up used oil.

Dispose of used oil and oily machine parts in accordance with national regulations.

The machine is equipped with a central oil-wick lubrication system. The bearings are supplied from the oil reservoir.

For topping off the oil reservoir, use only lubricating oil **DA 10** or oil of equivalent quality with the following specifications:

- Viscosity at 40 °C: 10 mm²/s
- Flash point: 150 °C

You can order the lubricating oil from our sales offices using the following part numbers.

Container	Part no.
250 ml	9047 000011
1 l	9047 000012
2 l	9047 000013
5 l	9047 000014

6.2.1 Lubricating the machine head



Proper setting

The oil level is between the minimum level marking and the maximum level marking.

Fig. 54: Lubricating the machine head

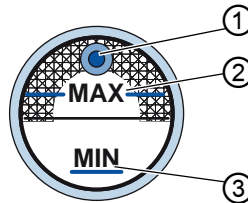

(1) - Refill opening

(2) - Maximum level marking

(3) - Minimum level marking



To lubricate the machine head:

1. Check the oil level indicator at the inspection glass every day.
2. If the inspection glass lights up red, the machine is not sufficiently supplied with oil.
3. If the oil level is below the minimum level marking (3): Pour oil through the refill opening (1) but no higher than the maximum level marking (2).

6.2.2 Lubricating the hook

CAUTION



Risk of injury!

Crushing and puncture possible.

Only lubricate the hook when the machine is switched off. Carry out function tests with utmost caution when the sewing machine is switched on.

The approved oil quantity for hook lubrication is a factory specification.



Proper setting

1. Hold a piece of blotting paper next to the hook.
 2. Allow the machine to run without thread and sewing material for 10 seconds with the sewing feet lifted and at a high speed.
- ↳ The blotting paper will show a thin strip of oil when sewing is complete.

Fig. 55: Lubricating the hook



(1) - Screw

To lubricate the hook:



1. Turn the screw (1):
 - counterclockwise: more oil is released
 - clockwise: less oil is released



Important

The released amount of oil does not change until the operating time has run a few minutes. Sew for several minutes before you check the setting again.

6.3 Servicing the pneumatic system

6.3.1 Setting the operating pressure

NOTICE

Property damage from incorrect setting!

Incorrect operating pressure can result in damage to the machine.

Ensure that the machine is only used when the operating pressure is set correctly.



Proper setting

Refer to the **Technical data** ( p. 145) chapter for the permissible operating pressure. The operating pressure cannot deviate by more than ± 0.5 bar.

Check the operating pressure on a daily basis.

Fig. 56: Setting the operating pressure

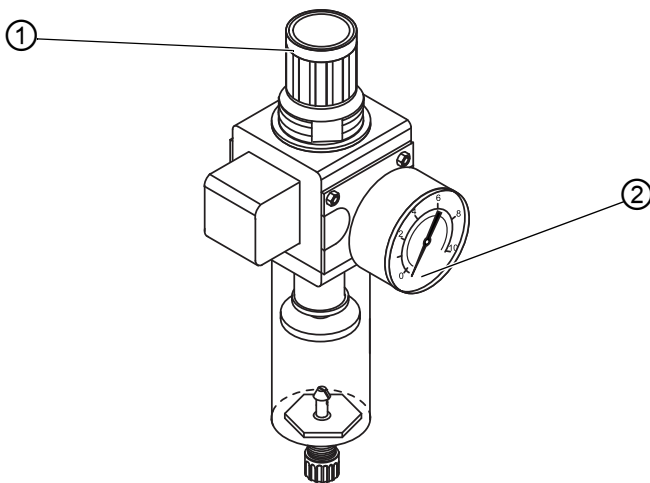

(1) - Pressure controller

(2) - Pressure gage

To set the operating pressure:



1. Pull the pressure controller (1) up.
2. Turn the pressure controller until the pressure gage (2) indicates the proper setting:
 - Increase pressure = turn clockwise
 - Reduce pressure = turn counterclockwise
3. Push the pressure controller (1) down.

6.3.2 Draining the water condensation

NOTICE

Property damage from excess water!

Excess water can cause damage to the machine.

Drain water as required.

Water condensation accumulates in the water separator (2) of the pressure controller.



Proper setting

Water condensation must not rise up to the level of the filter element (1).

Check the water level in the water separator (2) on a daily basis.

Fig. 57: Draining the water condensation

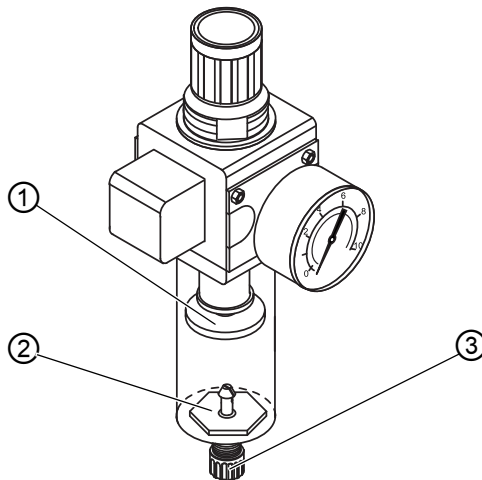

- (1) - Filter element
(2) - Water separator

- (3) - Drain screw

To drain water condensation:



1. Disconnect the machine from the compressed air supply.
2. Place the collection tray under the drain screw (3).
3. Loosen the drain screw (3) completely.
4. Allow water to drain into the collection tray.

5. Tighten the drain screw (3).
6. Connect the machine to the compressed air supply.

6.3.3 Cleaning the filter element

NOTICE

Damage to the paintwork from solvent-based cleaners!

Solvent-based cleaners damage the filter.

Use only solvent-free substances for washing out the filter tray.

Fig. 58: Cleaning the filter element

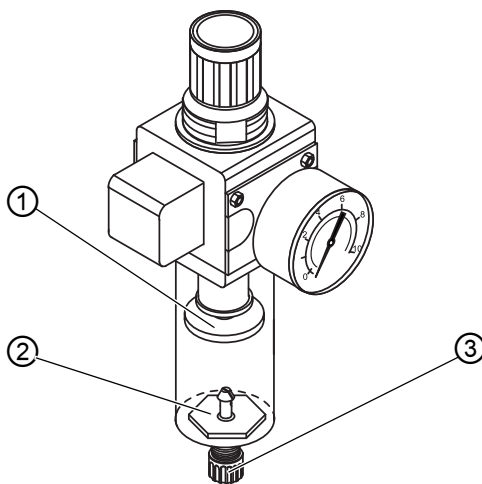

- (1) - Filter element
(2) - Water separator

- (3) - Drain screw

To clean the filter element:



1. Disconnect the machine from the compressed air supply.
2. Drain the water condensation (📖 p. 113).
3. Loosen the water separator (2).
4. Loosen the filter element (1).

5. Blow out the filter element (1) using a compressed air gun.
6. Wash out the filter tray using benzine.
7. Tighten the filter element (1).
8. Tighten the water separator (2).
9. Tighten the drain screw (3).
10. Connect the machine to the compressed air supply.

6.4 Parts list

A parts list can be ordered from Dürkopp Adler. Or visit our website for further information at:

www.duerkopp-adler.com



7 Setup

WARNING



Risk of injury from cutting parts!

Cutting injuries may be sustained while unpacking and setting up the machine.

Only qualified specialists may set up the machine.
Wear safety gloves

WARNING



Risk of injury from moving parts!

Crushing injuries may be sustained while unpacking and setting up the machine.

Only qualified specialists may set up the machine.
Wear safety shoes.

7.1 Checking the scope of delivery

The scope of delivery depends on your specific order. Check that the scope of delivery is correct after taking delivery.

7.2 Removing the transport locks

Remove all transport locks before setting up the machine:

- Lashing straps and wooden blocks from the machine head, the table and the stand
- Supporting wedges between machine arm and throat plate

7.3 Assembling the stand

Fig. 59: Assembling the stand

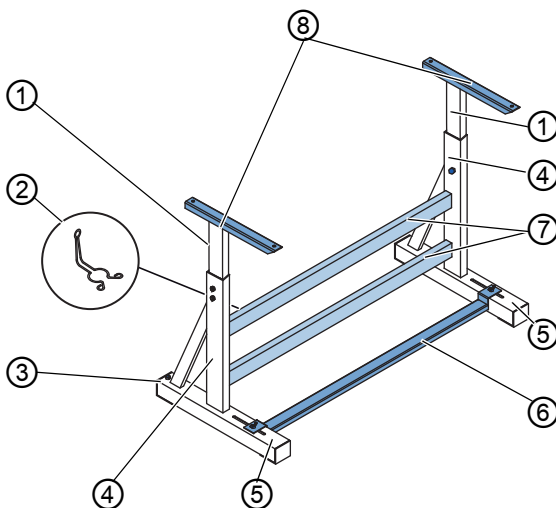

- | | |
|--------------------------|--------------------------------|
| (1) - Inner bar | (5) - Foot strut |
| (2) - Holder for oil can | (6) - Cross strut |
| (3) - Adjusting screw | (7) - Cross bar |
| (4) - Stand bar | (8) - Head section - inner bar |

To assemble the stand:



1. Screw the cross bar(s)* (7) onto the stand bars (4).
2. Screw the oil can holder (2) at the rear to the upper cross bar (7).
3. Screw the cross strut (6) to the foot struts (5).
4. Insert the inner bars (1) in such a way that the longer end of the head section (8) is above the longer end of the foot struts (5).
5. Tighten the inner bars (1) down so that both head sections (8) are at the same height.
6. **Important:** Turn the adjusting screw (3) so that the stand has even contact with the ground.

* Stand components for long arm machines have 2 cross bars, and the other stand components have 1 cross bar.

7.4 Assembling the pedal and setpoint device

Fig. 60: Assembling the pedal and setpoint device

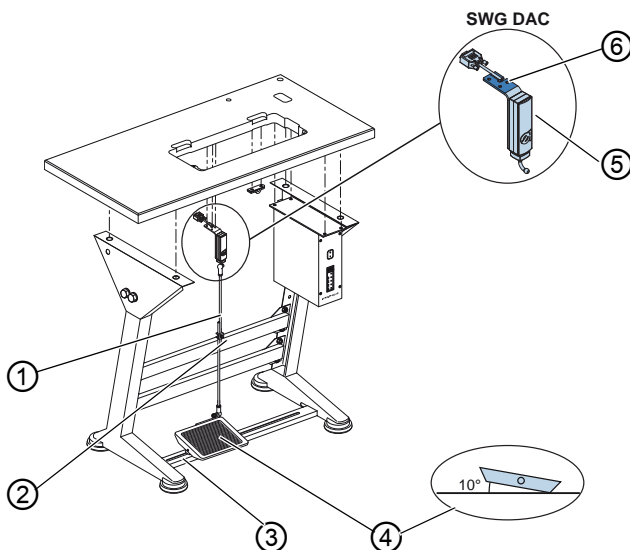

- | | |
|-------------------|-----------------------|
| (1) - Pedal rod | (4) - Pedal |
| (2) - Screw | (5) - Setpoint device |
| (3) - Cross strut | (6) - Bracket |

To assemble pedal and setpoint device:



- Fit the pedal (4) on the cross strut (3) and align it in such a way that the middle of the pedal is under the needle. The cross strut has elongated holes to allow for the alignment of the pedal.
- Tighten the pedal (4) on the cross strut (3).
- Screw the bracket (6) under the tabletop so that the pedal rod (1) runs to the pedal (4) at right-angles to the setpoint device (5).
- Screw the setpoint device (5) onto the bracket (6).
- Attach the pedal rod (1) with the ball sockets to the setpoint device (5) and to the pedal (4).
- Pull the pedal rod (1) to the correct length:



Proper setting

- 10° inclination with pedal (4) released
- Tighten the screw (2).

7.5 Tabletop

Ensure that the tabletop has sufficient load-bearing capacity and strength. If you want to make your own tabletop, use the dimensions given in the diagram **Appendix** (📖 p. 149) as a template.

7.5.1 Completing the tabletop

The tabletop is optional. Drawings are provided in the appendix to allow you to independently assemble a tabletop (📖 p. 149).

Fig. 61: Completing the tabletop

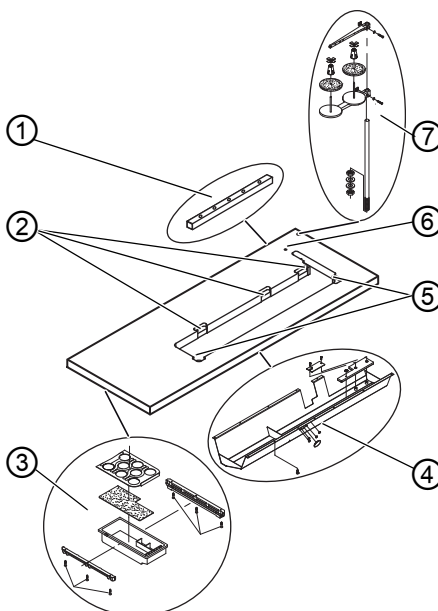

- | | |
|------------------|------------------|
| (1) - Cable duct | (5) - Recess |
| (2) - Slot | (6) - Hole |
| (3) - Drawer | (7) - Reel stand |
| (4) - Oil pan | |

To complete the tabletop:



1. Screw the drawer (3) with the left-hand bracket to the underside of the tabletop.

2. Screw the oil pan (4) in place under the slot for the machine.
3. Screw the cable duct (1) to the underside of the tabletop.
4. Insert the reel stand (7) into the hole.
5. Assemble the reel stand (7) with nut and washer.
6. Tighten the thread reel holder and the unwinding bracket on the reel stand (7) in such a way that they are exactly opposite each other.
7. Insert the plug (6) in the hole.
8. Fit the lower hinge parts into the slots (2).
9. Insert the rubber corners into the recesses (5).

7.5.2 Assembling the tabletop to the stand

Fig. 62: Assembling the tabletop to the stand

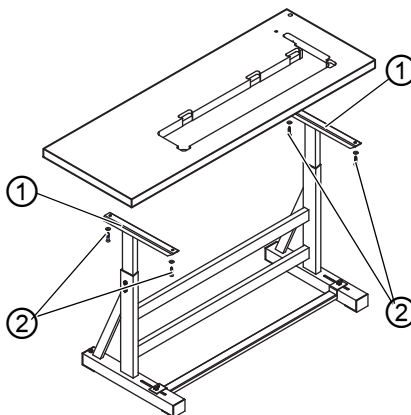

(1) - Head section

(2) - Screws

To assemble the tabletop to the stand:



1. Place the tabletop on the head sections (1) of the inner bars.
2. Use the screws (2) to fasten the tabletop at the screw holes of the head sections.

7.6 Setting the working height

WARNING



Risk of injury from moving parts!

The tabletop can sink under its own weight when the screws on the stand bars are loosened. Crushing possible.

Ensure that your hands are not jammed when loosening the screws.

CAUTION



Risk of musculoskeletal damage from incorrect setting!

The operator can sustain musculoskeletal damage if failing to comply with the ergonomic requirements.

Adjust the working height to the body height of the person who will operate the machine.

The working height is continuously adjustable between 750 and 900 mm (clearance between the floor and upper edge of the tabletop).

Fig. 63: Setting the working height

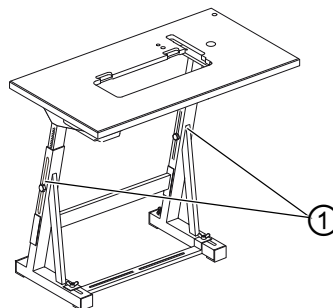

(1) - Screws

To set the working height:



1. Loosen the screws (1) on the stand bars.
2. Set the tabletop to the desired height.



Important

Pull out or push in the tabletop evenly at both sides to prevent it from jamming.

3. Tighten the screws (1) on the stand bars.

7.7 Assembling the control

Fig. 64: Assembling the control

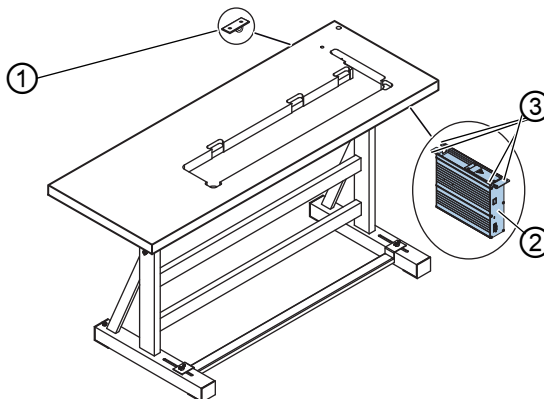

(1) - Strain relief mechanism
(2) - Control

(3) - Screw holder

To assemble the control:



1. Screw the control (2) onto the 4 screw holders (3) under the tabletop.
2. Clamp the power cable of the control (2) into the strain relief mechanism (1).
3. Screw the strain relief mechanism (1) under the tabletop.

7.8 Inserting the machine head

WARNING



Risk of injury from moving parts!

The machine head is very heavy.
Crushing possible.

Ensure that your hands are not jammed when inserting the machine head.

NOTICE

Property damage may occur!

Cable may sustain damage and impair the operation of the machine.

Always lay the cables so as not to create any chafing or pinching points.

Fig. 65: Inserting the machine head

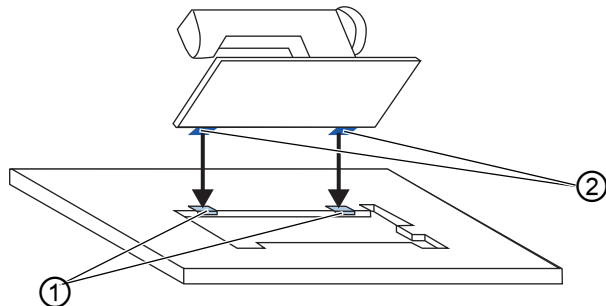

(1) - Rubber inlays

(2) - Upper hinge parts

To insert the machine head:



1. Screw the upper hinge parts (2) onto the machine head.
2. Guide the cables through the tabletop with great care so as not to create any chafing or pinching points.
3. Insert the machine head from above at an angle of 45°.
4. Insert the upper hinge parts (2) into the rubber inlays (1).

5. Tilt the machine head forward and insert it into the slot in the tabletop.

7.9 Assembling the control panel

Fig. 66:



(1) - Control panel
(2) - Plug

(3) - Bracket

To assemble the control panel:



1. Tighten the control panel (1) on the bracket (3).
2. Insert the plug (2) of the connecting cable into the socket of the control panel (1).

7.10 Assembling the knee button

Fig. 67: Assembling the knee button

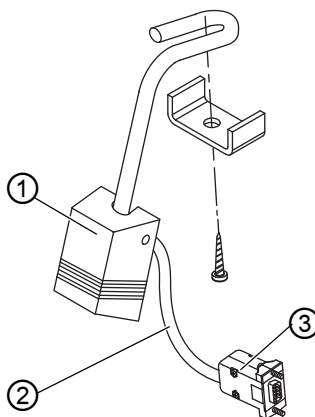

(1) - Knee button
(2) - Connecting cable

(3) - Plug

To assemble the knee button:



1. Screw the knee button (1) in front of the oil pan firmly in place under the tabletop.
2. Guide the connecting cable (2) to the back between the oil pan and the control.
3. Insert the plug (3) of the connecting cable into the socket of the control.

7.11 Assembling the oil extraction line

Fig. 68: Assembling the oil extraction line

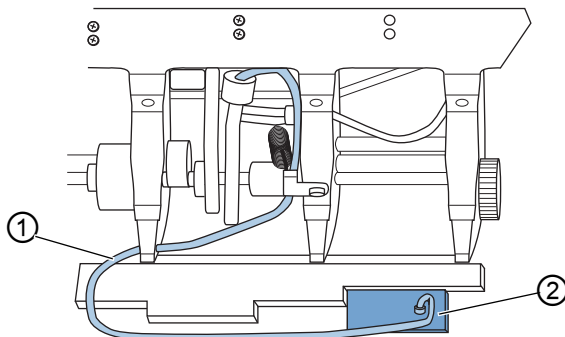

(1) - Tube

(2) - Filter

To assemble the oil extraction line:



1. Tilt the machine head.
2. Tighten the filter (2) inside the oil pan with the plastic adapter to the right.
3. Insert the tube (1) of the oil extraction line into the plastic adapter.

7.12 Electrical connection

DANGER



Risk of death from live components!

Unprotected contact with electricity can result in serious injuries or death.

Only qualified specialists may perform work on electrical equipment.



Important

The voltage on the type plate of the sewing motor must correspond to the mains voltage.

7.12.1 Connecting the sewing lamp transformer

DANGER



Risk of death from electric shock!

When the sewing machine is switched off at the main switch, the supply voltage for the sewing lamp remains active.

Disconnect the power plug before assembling the sewing lamp with sewing lamp transformer. Ensure the power plug cannot be unintentionally reinserted.

Fig. 69: Connecting the sewing lamp transformer (1)



(1) - Sewing lamp transformer

Assembling the sewing lamp transformer



1. Screw the sewing lamp transformer (1) in place at the pre-drilled holes under the tabletop.
2. Assemble the connecting cable under the tabletop using cable ties.

- Establish the plug connection to the supply line for the sewing lamp.

Fig. 70: Connecting the sewing lamp transformer (2)

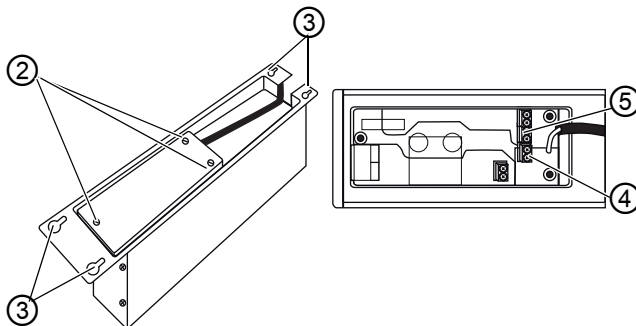

(2) - Adapter cover screws
(3) - Screw holder

(4) - 24V/X5 connection
(5) - X3 connection

Connecting the sewing lamp transformer



- Loosen the screw holder (3) for the control far enough to allow the control to be removed.
- Remove the control.
- Loosen the adapter cover screws (2).
- Connect the supply line:
 - for additional sewing lamps to be assembled to the X3 port (5)
 - for integrated LED sewing lamps connected to the 24V/X5 port (4)

7.12.2 Establishing equipotential bonding

DANGER



Risk of death from live components!

Unprotected contact with electricity can result in serious injuries or death.

Disconnect the power plug before establishing equipotential bonding. Ensure the power plug cannot be unintentionally reinserted.

The protective earth conductor conducts away any static charging of the machine head.

Fig. 71: Establishing equipotential bonding

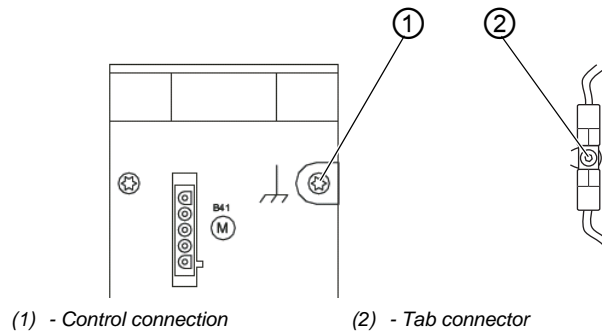

(1) - Control connection

(2) - Tab connector

To establish equipotential bonding:



1. Tilt the machine head.
2. Feed the equipotential bonding cable from the connection (1) on the rear side of the control through the slot in the tabletop and plug it onto the tab connector (2) on the base plate.

7.12.3 Connecting the control

DANGER



Risk of death from live components!

Unprotected contact with electricity can result in serious injuries or death.

Disconnect the power plug before connecting the control. Ensure the power plug cannot be unintentionally reinserted.

To connect the control:



1. Connect the control as specified in the wiring diagram ( p. 149).

7.13 Pneumatic connection (optional)

NOTICE

Property damage from oily compressed air!

Oil particles in the compressed air can cause malfunctions of the machine and soil the sewing material.

Ensure that no oil particles enter the compressed air supply.

NOTICE

Property damage from incorrect setting!

Incorrect system pressure can result in damage to the machine.

Ensure that the machine is only used when the system pressure is set correctly.

The pneumatic system of the machine and of the additional equipment must be supplied with dry and oil-free compressed air. The supply pressure must lie between 8 and 10 bar.



Information

The pneumatic connection package is available under part number 0797 003031. It consists of:

- System connection hose (length 5 m, diameter 9 mm)
- Hose connectors and hose clamps
- Coupling socket and coupling plug

7.13.1 Assembling the compressed air maintenance unit

Fig. 72: Assembling the compressed air maintenance unit

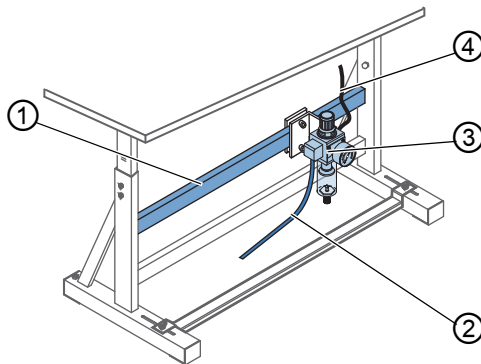

- | | |
|------------------------------|------------------------|
| (1) - Cross bar | (3) - Maintenance unit |
| (2) - System connection hose | (4) - Machine hose |

To assemble the compressed air maintenance unit:



1. Assemble the maintenance unit (3) to the upper cross bar (1) of the stand using the bracket, screws and clip.
2. Connect the machine hose (4) coming out of the machine head to the maintenance unit (3) at the top right.
3. Connect the system connection hose (2) to the pneumatic system.

7.13.2 Setting the operating pressure

NOTICE

Property damage from incorrect setting!

Incorrect operating pressure can result in damage to the machine.

Ensure that the machine is only used when the operating pressure is set correctly.



Proper setting

Refer to the **Technical data** (📖 p. 145) chapter for the permissible operating pressure. The operating pressure cannot deviate by more than ± 0.5 bar.

Fig. 73: Setting the operating pressure

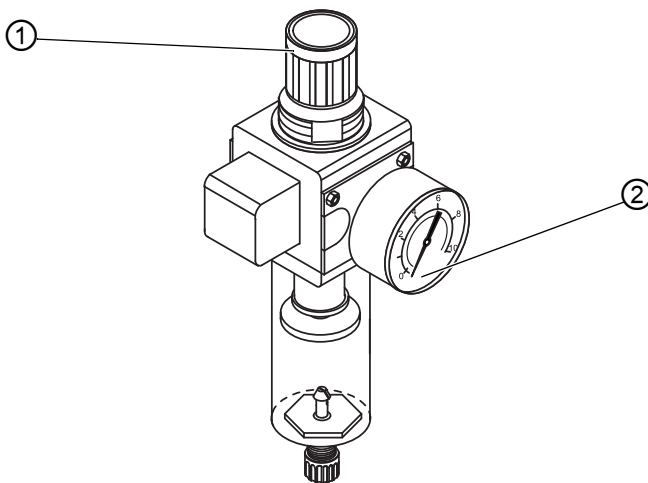

(1) - Pressure controller

(2) - Pressure gage

To set the operating pressure:



1. Pull the pressure controller (1) up.

2. Turn the pressure controller until the pressure gage (2) indicates the proper setting:
 - Increase pressure = turn clockwise
 - Reduce pressure = turn counterclockwise
3. Push the pressure controller (1) down.

7.14 Checking the lubrication

All wicks and felt bits of the machine head are soaked in oil at the factory. This oil is conveyed to the reservoir during use. This is why you should avoid filling too much oil during initial filling.

Fig. 74: Checking the lubrication

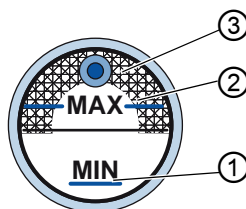

(1) - Minimum level marking
(2) - Maximum level marking

(3) - Inspection glass

To check the lubrication:



1. Sew with the machine for approx. 1 minute.
2. Check at the inspection glass (3) whether the warning indicator is lit red or the oil level has dropped below the minimum marking (1).
3. If this is the case, top off oil ( p. 109).

7.15 Performing a test run

WARNING





Risk of injury from moving, cutting and sharp parts!

Crushing, cutting and punctures are possible.









If possible, only change settings when the machine is switched off.

When setup is complete, perform a test run to check the functionality of the machine. To this end, adjust the machine to the sewing material requirements.

To do so, read the corresponding chapters in the  *Operating Instructions*. Read the corresponding chapters in the  *Service Instructions* in order to make adjustments to the machine if the sewing results do not conform to the requirements.

To perform a test run:



1. Insert needle ( p. 22).
2. Wind on the hook thread, ( p. 36).
3. Insert the bobbin ( p. 38).
4. Thread hook thread ( p. 38).
5. Thread needle thread ( p. 26).
6. Set the thread tensions to the sewing material being sewn ( p. 40).
7. Set the needle thread regulator to the sewing material being sewn ( p. 42).
8. Set the sewing foot pressure to the sewing material being sewn.
9. Set the sewing foot stroke to the sewing material being sewn.
10. Set stitch length.
11. Transfer the desired quick function from the push button to the favorite button ( p. 47).
12. Start the sewing test at low speed.
13. Gradually increase the speed until the working speed is reached.

8 Decommissioning

WARNING



Risk of injury from a lack of care!

Serious injuries may occur.

ONLY clean the machine when it is switched off.
Allow ONLY trained personnel to disconnect the machine.

CAUTION



Risk of injury from contact with oil!

Oil can cause a rash if it comes into contact with skin.

Avoid skin contact with oil.

If oil has come into contact with your skin, wash the affected areas thoroughly.

You need to perform a number of activities if the machine is to be shut down for a longer period of time or completely decommissioned.

To decommission the machine:



1. Switch off the machine.
2. Unplug the power plug.
3. If applicable, disconnect the machine from the compressed air supply.
4. Remove residual oil from the oil pan using a cloth.
5. Cover the control panel to protect it from soiling.
6. Cover the control to protect it from soiling.
7. Cover the entire machine if possible to protect it from contamination and damage.

9 Disposal

CAUTION



Risk of environmental damage from improper disposal!

Improper disposal of the machine can result in serious environmental damage.

ALWAYS comply with the national regulations regarding disposal.

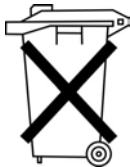

The machine must not be disposed of in the normal household waste.

The machine must be disposed of in a suitable manner in accordance with all applicable national regulations.

When disposing of the machine, be aware that it consists of a range of different materials (steel, plastic, electronic components, etc.). Follow the national regulations when disposing these materials.

10 Troubleshooting

10.1 Customer Service

Contact for repairs and issues with the machine:

Dürkopp Adler AG

Potsdamer Str. 190
33719 Bielefeld, Germany

Tel. +49 (0) 180 5 383 756

Fax +49 (0) 521 925 2594

Email: service@duerkopp-adler.com







Internet: www.duerkopp-adler.com



10.2 Messages of the software

Should a fault occur, refer to the  *Service Instructions* or turn to Customer Service. Do not attempt to correct the error yourself.

10.3 Errors in sewing process

Error	Possible causes	Remedial action
Unthreading at seam beginning	Needle thread pretension is too firm	Check needle thread pretension ( p. 41).
Thread breaking	Needle thread and hook thread have not been threaded correctly	Check threading path ( p. 26).
	Needle is bent or sharp-edged	Replace the needle ( p. 22).
	Needle is not inserted correctly into the needle bar	Insert the needle correctly into the needle bar ( p. 22).
	The thread used is unsuitable	Use recommended thread ( p. 145).
	Thread tensions are too tight for the thread used	Check thread tensions ( p. 40).
	Thread-guiding parts, such as thread guides, are sharp-edged	Check threading path ( p. 26).
	Throat plate or hook have been damaged by the needle	Have parts reworked by qualified specialists

Error	Possible causes	Remedial action
Missing stitches	Needle thread and hook thread have not been threaded correctly	Check threading path (📖 p. 26, 📖 p. 38).
	Needle is blunt or bent	Replace the needle (📖 p. 22).
	Needle is not inserted correctly into the needle bar	Insert the needle correctly into the needle bar (📖 p. 22).
	The needle thickness used is unsuitable	Use recommended needle thickness (📖 p. 145).
	The reel stand is installed incorrectly	Check the assembly of the reel stand
	Thread tensions are too tight	Check thread tensions (📖 p. 40).
	Throat plate or hook have been damaged by the needle	Have parts reworked by qualified specialists
	Distance from the hook to the needle is not set correctly	Set the correct distance (📖 Service Instructions)
Loose stitches	Thread tensions are not adjusted to the sewing material, the sewing material thickness or the thread used	Check thread tensions (📖 p. 40).
	Needle thread and hook thread have not been threaded correctly	Check threading path (📖 p. 26, 📖 p. 38).
Needle breakage	Needle thickness is unsuitable for the sewing material or the thread	Use recommended needle thickness (📖 p. 145).

11 Technical data

Noise emission

Workplace-specific emission value as per DIN EN ISO 10821:

$L_{pA} = 79 \text{ dB (A)}$; $K_{pA} = 0.58 \text{ dB (A)}$ at

- Stitch length: 6.0 mm
- Sewing foot stroke, alternating: 7.0 mm
- Speed: 1500 rpm
- Sewing material: 2-layer Skai; 1.6 mm 900 gr/mm²; DIN 53352

Data and characteristic values

Technical data	Unit	867-190922-M	867-190925-M	867-190929-M	867-190942-M	867-190945-M	867-190946-M	867-190949-M	867-290922-M	867-290942-M	867-290945-M
Machine type		Double lockstitch 301									
Hook type vertical, (L) large (26 mm)		•	•	•					•		
Hook type vertical, (XXL) extra large (32 mm)					•	•	•	•		•	•
Number of needles		1						2			
Needle system		134-35									
Needle strength	[Nm]	90 - 180									
Thread strength	[Nm]	120/3 - 10/3 (short thread cutter, KFA max. 15/3)									
Stitch length	[mm]	12/12									
Speed maximum	[min ⁻¹]	3800			3400				3500	3200	
Speed set at the factory	[min ⁻¹]	3400						3000			
Sewing foot stroke	[mm]	9									

Technical data	Unit	867-190922-M	867-190925-M	867-190929-M	867-190942-M	867-190945-M	867-190946-M	867-190949-M	867-290922-M	867-290942-M	867-290945-M	
Lifting height	[mm]	20										
Mains voltage	[V]	230										
Mains frequency	[Hz]	50/60										
Operating pressure	[bar]	6 (only required in combination with optional equipment)										
Length	[mm]	740										
Width	[mm]	220										
Height	[mm]	460										
Weight	[kg]	59							60			

Characteristics

- sewing motor (DA direct drive) integrated into the machine head with max. speed of 3,800 rpm (depending on the hook size used)
- Control DAC comfort with OP3000 control panel
- Actuators without compressed air
- large (L) or extra-large (XXL) vertical hook
- electromagnetic thread cutter
- programmable setting of the stitch length via stepper motor (max. 12 mm)
- programmable adjustment of the alternating sewing feet via stepper motor (max. 9mm)
- Material thickness detection with programmable functions (sewing speed, sewing foot pressure, sewing foot stroke and thread tension)
- programmable sewing foot pressure via stepper motor (in combination with compression spring); depending on material thickness detection
- Sewing foot lift controlled by stepper motor (max. 20 mm, same actuator as the one used for the sewing foot pressure)

- programmable thread tension (electromagnetically) with speed compensation; also depending on material thickness detection
- electronic handwheel (ENP 10-1)
- integrated winder with winding assistant
- Safety snap-on coupling prevents any misadjustment or damage to the hook in the event of a thread jamming
- automatic wick lubrication with an inspection glass housed in the arm for lubricating the machine and the hook (including low oil level warning light)
- all subclasses with 6 push buttons, additional button element can be assigned push button functions
- Use of CTB bobbins in combination with cylindrical braking and lifting spring, hook covers with inspection glasses
- integrated LED sewing lamp including power supply and dimming function
- intuitive control software with graphical user interface
- up to 999 different seam programs supporting a maximum of 30 individual seam sections each. Sequential mode for a maximum of 9 interlinked seam programs

Fig. 76: Wiring diagram (1)

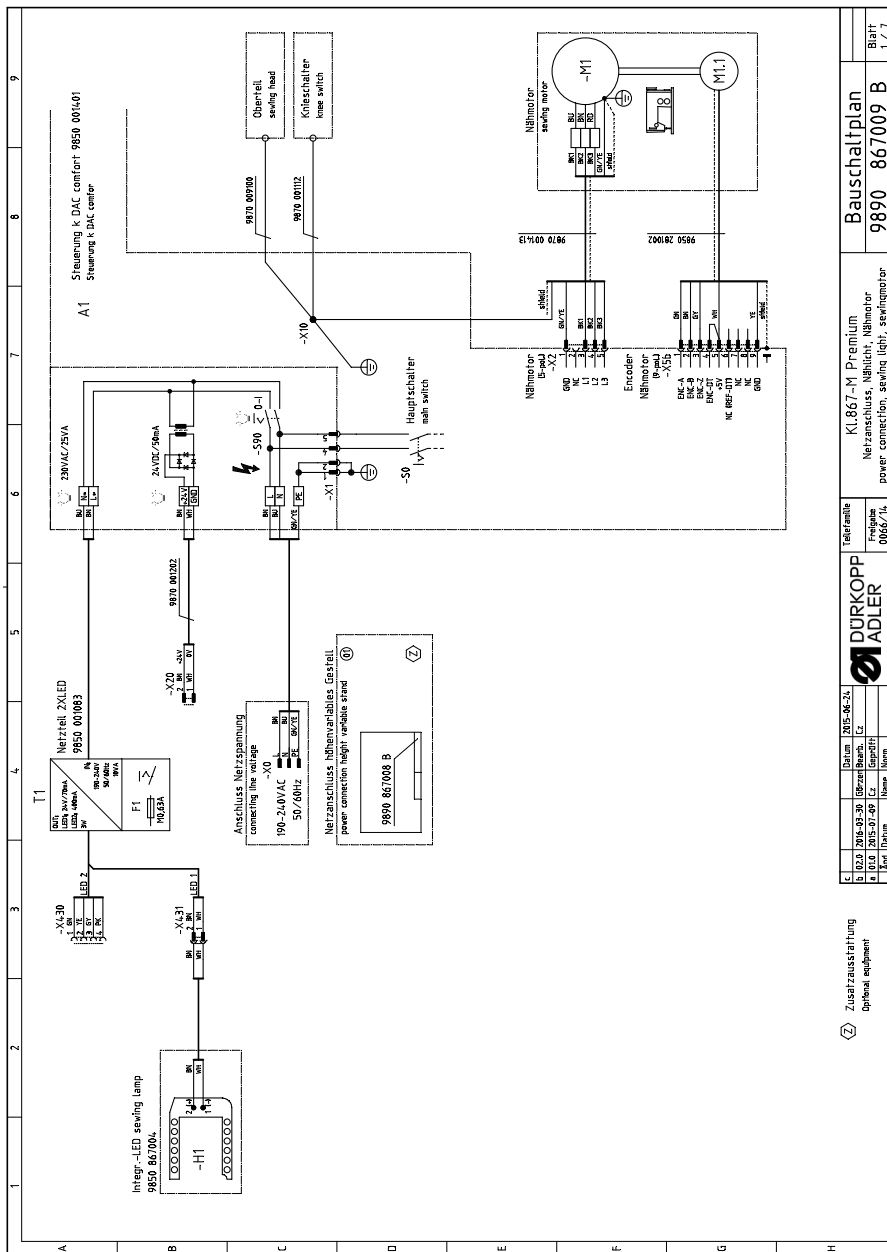

Zusatzausstattung Optional equipment		Datum Date		985-98-20	
a	10.0	2016-02-30	Gezeichnet Drawn	Lz	
b	10.0	2015-01-09	Gezeichnet Drawn	Lz	
c	10.0	2015-01-09	Gezeichnet Drawn	Lz	
d	10.0	2015-01-09	Gezeichnet Drawn	Lz	
Terminzahl Drawing No.		Terminzahl Drawing No.		Terminzahl Drawing No.	
0066/74		0066/74		0066/74	
DÜRKOPP ADLER		DÜRKOPP ADLER		DÜRKOPP ADLER	
KI.867-M Premium Netzananschluss, Nählicht, Nähmotor power connection, sewing light, sewing motor		KI.867-M Premium Netzananschluss, Nählicht, Nähmotor power connection, sewing light, sewing motor		KI.867-M Premium Netzananschluss, Nählicht, Nähmotor power connection, sewing light, sewing motor	
Bauschaltplan 9890 867009 B		Bauschaltplan 9890 867009 B		Bauschaltplan 9890 867009 B	
Blatt 1 / 7		Blatt 1 / 7		Blatt 1 / 7	

Fig. 77: Wiring diagram (2)

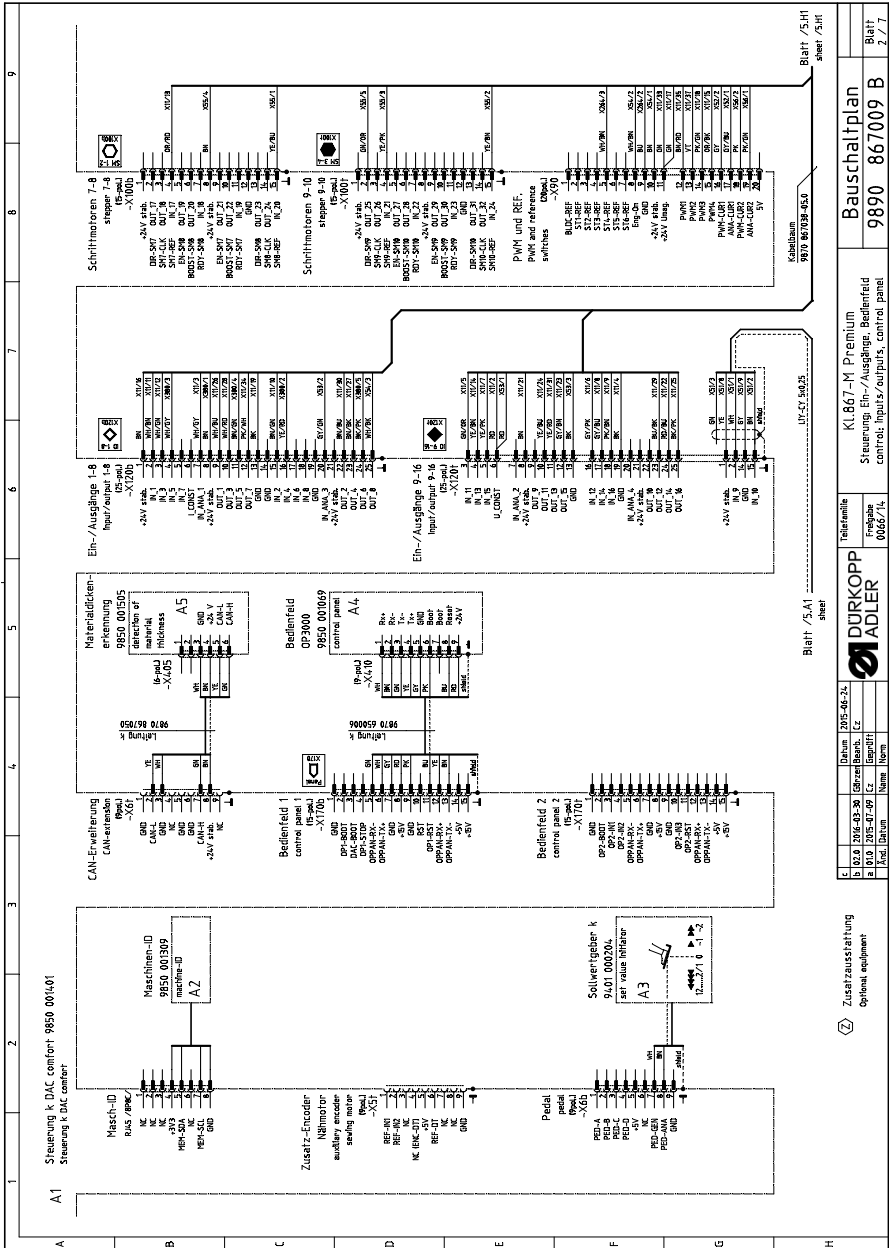

Blatt / 5/11
sheet / 5/11

Bauschaltplan
9890 867009 B

KL.867-M Premium
Steuerung Ein-/Ausgänge, Bedienfeld
control inputs/outputs, control panel

Teilenummer
Fragebogen
00657/L

DURKOPP ADLER logo

Zusatz-ausstattung
Optional equipment

Code	Item	Quantity	Unit
a	1015-040-2/L		
b	1015-043-3/L		
c	1015-049-1/L		
d	1015-049-2/L		

Fig. 78: Wiring diagram (3)

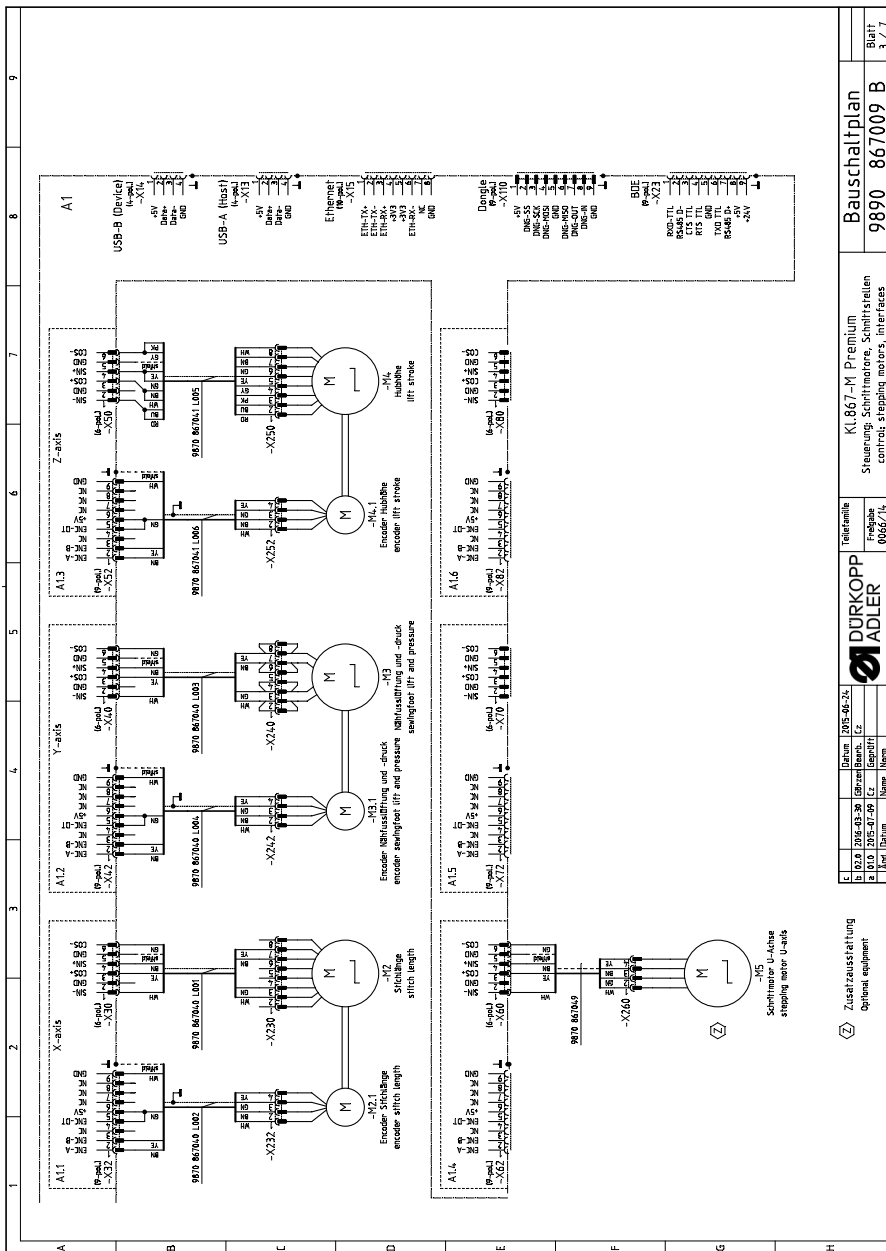

Blatt 3 / 7																	
Bauschaltplan 9890 867009 B																	
Kl.867-M Premium Steuerung, Schrittmotore, Schnittstellen control; stepping motors, interfaces																	
Telefonnr. Frageb. 00657/L																	
<table border="1"> <tr> <td>Druck</td> <td>1305-46-31</td> </tr> <tr> <td>Gezeichnet</td> <td></td> </tr> <tr> <td>Geprüft</td> <td></td> </tr> <tr> <td>Notizen</td> <td></td> </tr> </table>	Druck	1305-46-31	Gezeichnet		Geprüft		Notizen		<table border="1"> <tr> <td>Druck</td> <td>1305-46-31</td> </tr> <tr> <td>Gezeichnet</td> <td></td> </tr> <tr> <td>Geprüft</td> <td></td> </tr> <tr> <td>Notizen</td> <td></td> </tr> </table>	Druck	1305-46-31	Gezeichnet		Geprüft		Notizen	
Druck	1305-46-31																
Gezeichnet																	
Geprüft																	
Notizen																	
Druck	1305-46-31																
Gezeichnet																	
Geprüft																	
Notizen																	
 Optionales Equipment Schrittmotor U-Achse stepping motor U-axis																	

Fig. 79: Wiring diagram (4)

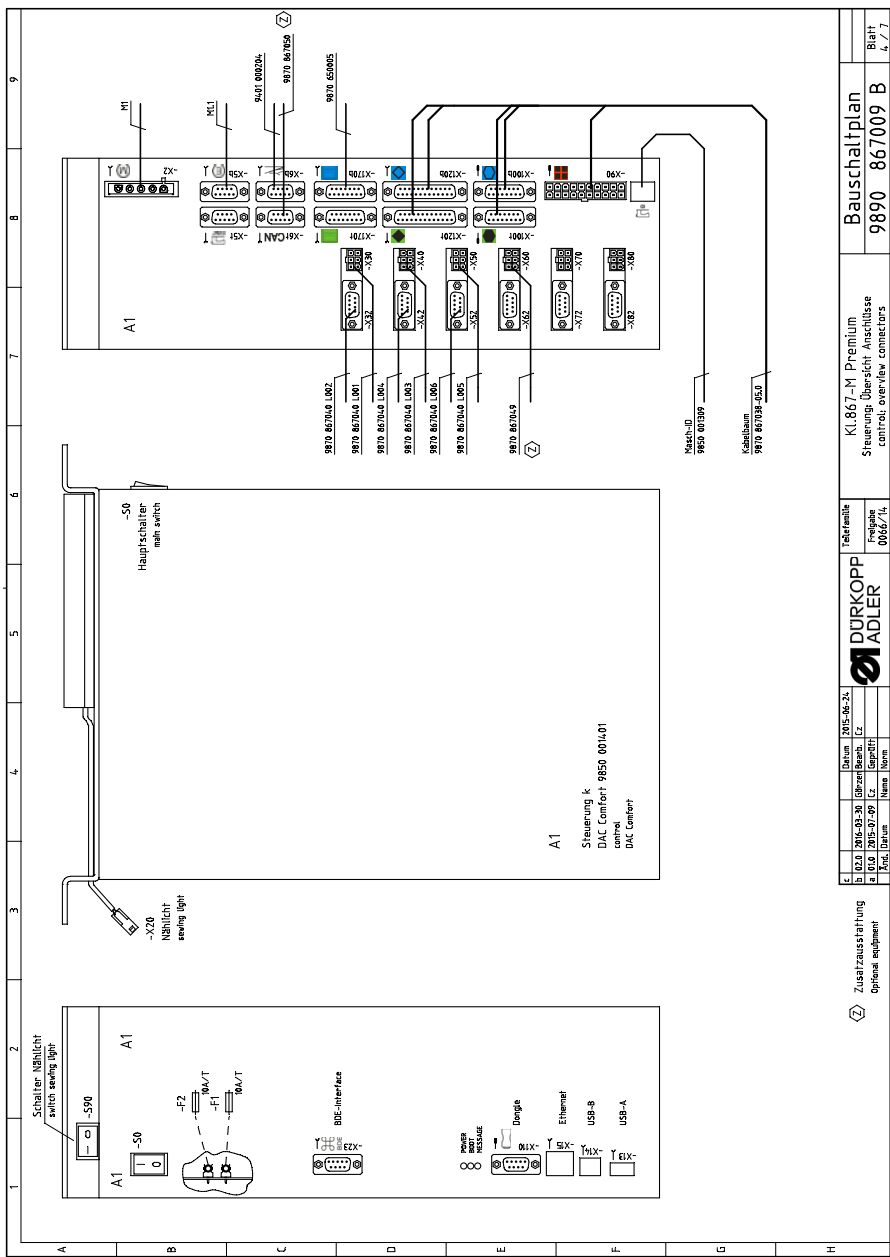

Zusatzausstattung Optional equipment		Teilenummer Freigelegte 00067/14		Bauteilnummer 9890 867009 B		Blatt 4 / 7	
Z		DURKOPP ADLER		KI.867-M Premium Steuerung-Übersicht Anschlüsse control overview connectors			
6	02.0	2815-06-24	02.0	2815-03-30	Übertrag.	02.0	2815-07-09
		Typ		Item	Item		Item

Fig. 80: Wiring diagram (5)

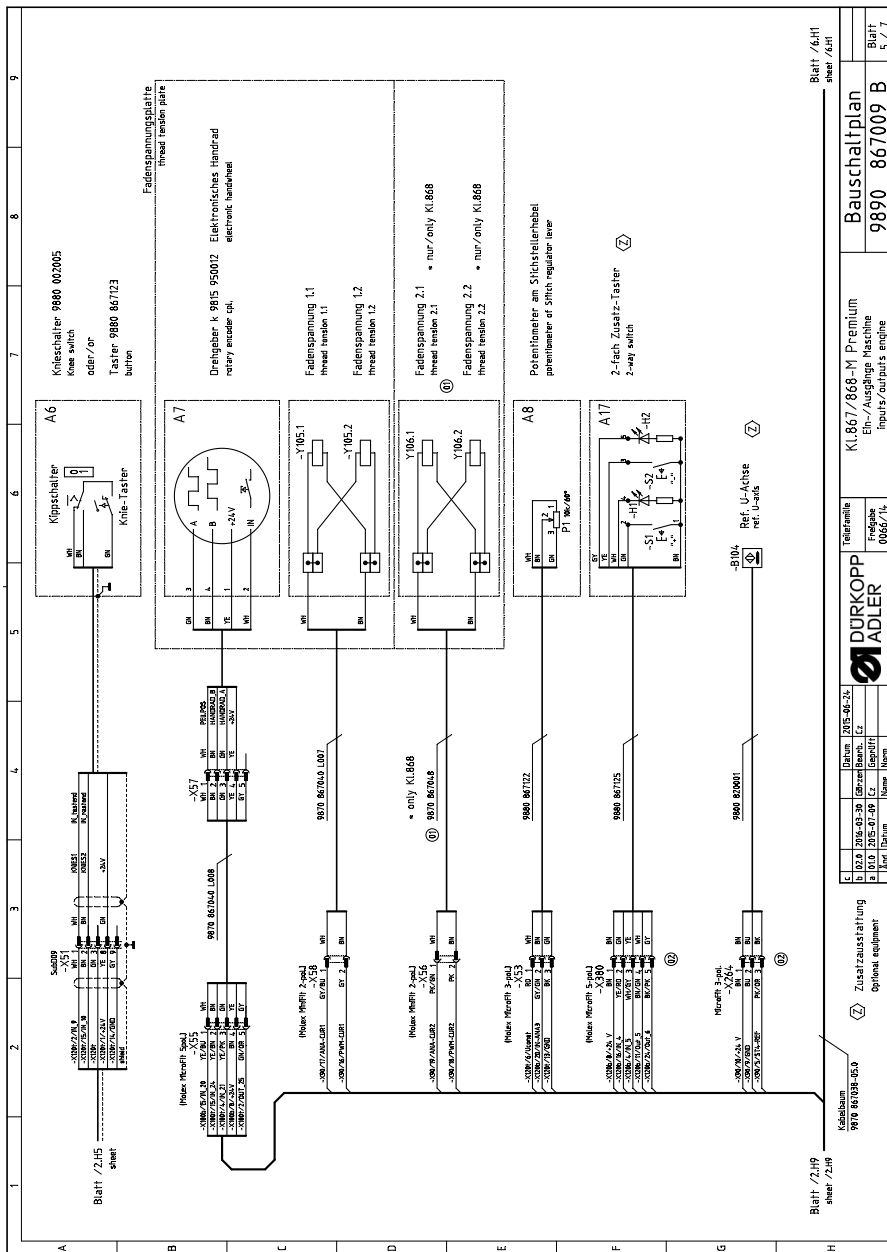

Blatt / 64
Sheet / 64

Bauschaltplan
9890 867009 B

KI.867/866-M Premium
Elt.-/Ausgänge Maschine
inputs/outputs engine

Teilermitteln
Findpage
00667/L

DURKOPP ADLER

Code	Index	Index	Index
f	02.0	2025-03-20	0202
b	02.0	2025-03-20	0202
a	02.0	2025-03-20	0202

Zusatzausstattung
Optional equipment

Kabelbaum
9870 867038-05.0

Blatt / 2419
Sheet / 2419

Fig. 82: Wiring diagram (7)

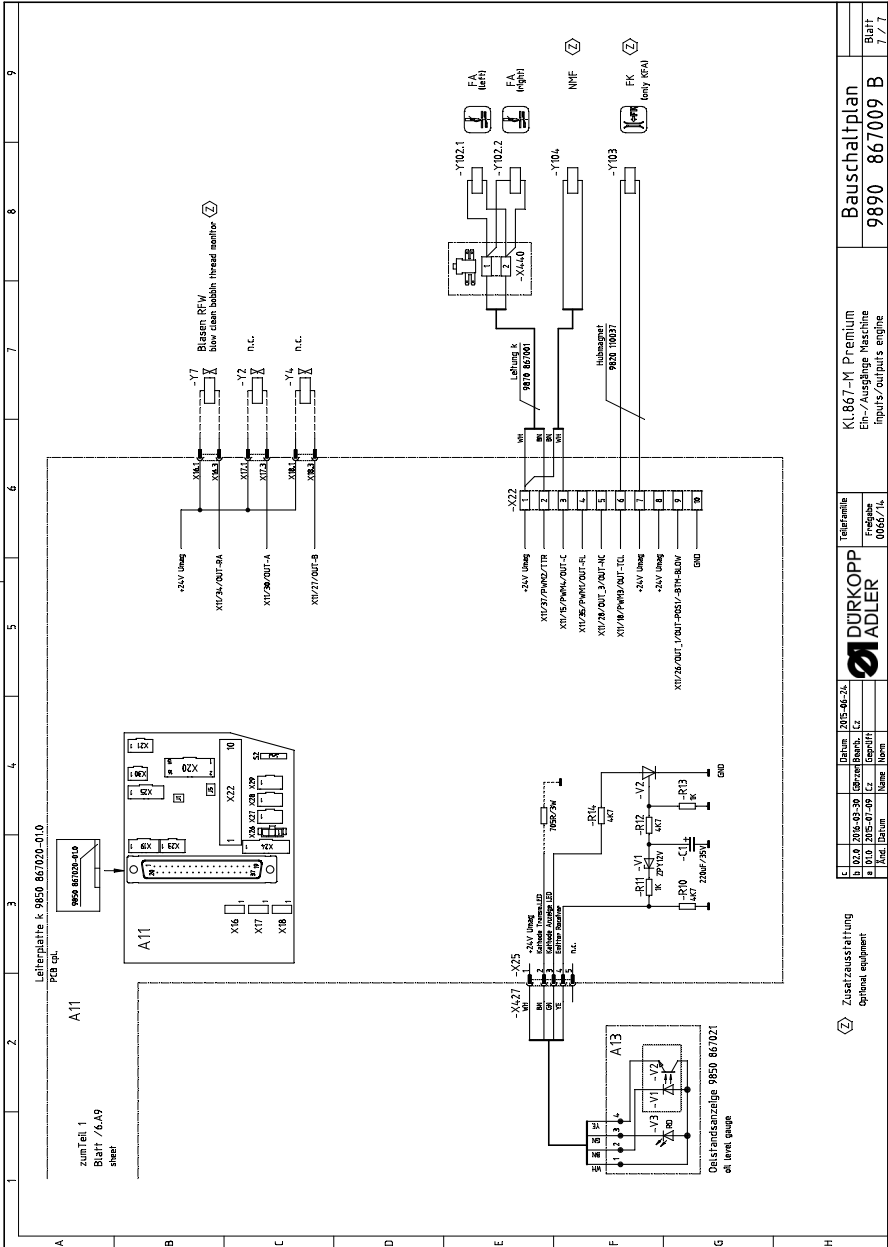

				Bauschaltplan				Blatt	
				9890 867009 B				7 / 7	
				KL867-M Premium					
				Ein-/Ausgänge Maschine					
				inputs/outputs engine					
				DÜRKOPP ADLER					
Teilernte				Teilteil					
Freigabe				Freigabe					
0065/1L				0065/1L					
1	2	3	4	5	6	7	8	9	

DÜRKOPP ADLER AG

Potsdamer Straße 190

33719 Bielefeld

GERMANY

Phone +49 (0) 521 / 925-00

E-mail service@duerkopp-adler.com

www.duerkopp-adler.com

